

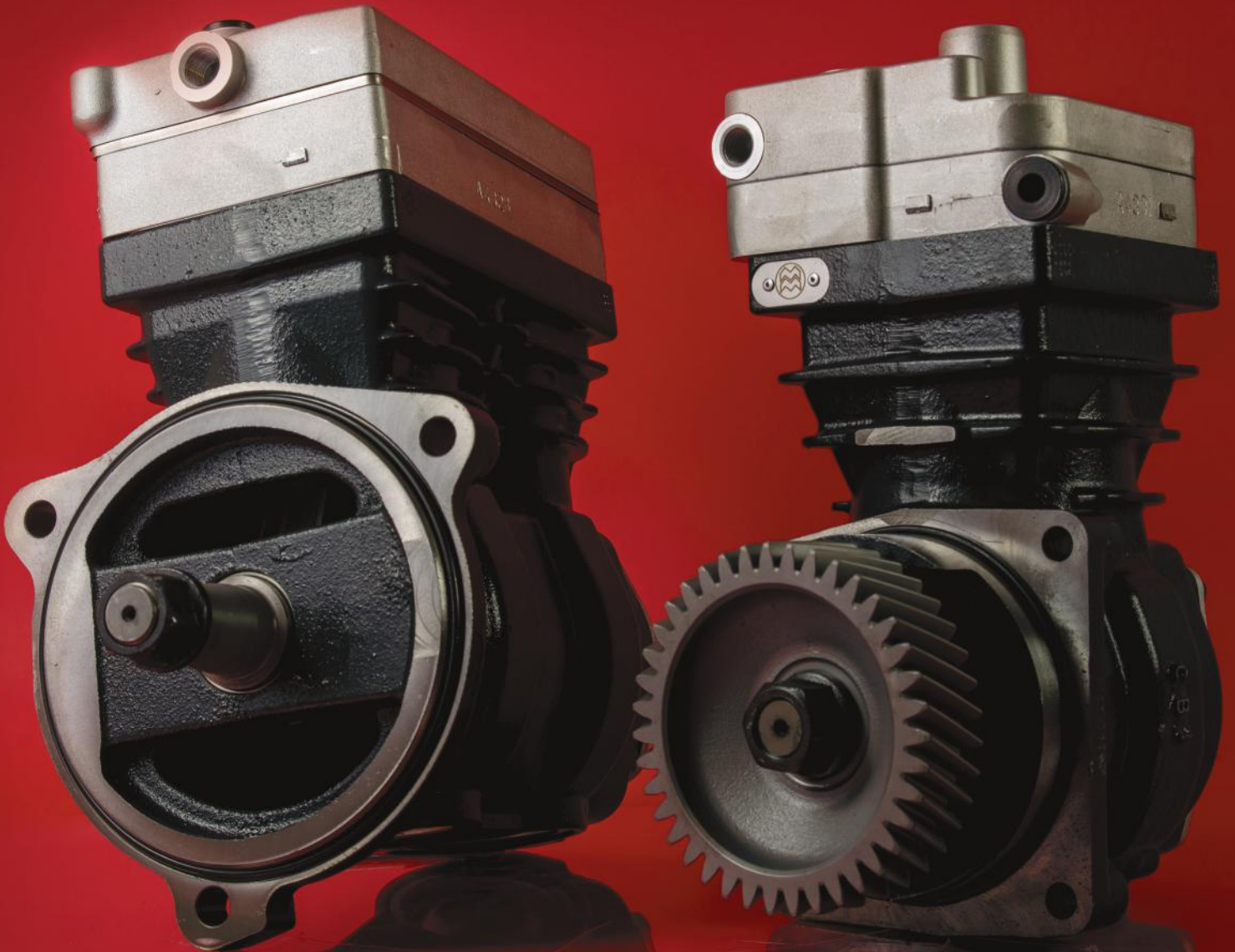

Wabco Catalogue

Issue 2



The airbrake specialist
40 years of experience

Majorsell Limited was established in 1980 as a reconditioning workshop of air brake equipment for commercial vehicles and off-road equipment, specialising in the repair of spring brakes and brake valves. As quality parts were hard to obtain, the decision was made to introduce a range of Majorsell air brake parts, primarily for use in its own workshop. This then became the start of the kit programme for which Majorsell is now internationally renowned. The range of kits offered has now evolved from just brake valves to air dryers, clutch servos, calipers and of course compressors.

The range of Majorsell compressor repair kits and components has increased continually during the last 30 years and is now probably the most extensive range of aftermarket compressor parts offered by a single company in the world. All of our compressor kits are designed with the rebuilder in mind to offer high quality and maximum choice whilst keeping costs to a minimum. They are all built in our UK warehouse to our specification and all of our compressor parts are used in our own reconditioning workshop.

In early 2011 we moved to a much larger facility in West Bromwich and invested a substantial amount in new machinery for our workshop, including a brand new test machine. In 2012 another building was purchased to accommodate the increase in demand for our reconditioned compressors and in 2014 an expansion to our existing workshop was completed.

Majorsell has been exporting since 1988 and now exports to over 70 countries. Our customers include small workshops and rebuilders as well as fleet operators and large distributors. We pride ourselves on our customer service and attention to detail. All of our parts are carefully packed and are easily identifiable in our distinctive Majorsell packaging. Majorsell is an internationally recognised brand which is something we are very proud of.

All Majorsell parts are alternative to OE and are replacements to those of all the leading makes of air brake and truck manufacturers. Over the years we have developed a large database of cross references and technical information, all of which is available on our website. To avoid confusion with any other manufacturer we have our own unique part numbering system.

In addition to air brake parts we also offer a comprehensive range of caliper parts and air conditioning compressors as well as ancillary items and workshop consumables. We are also pleased to be official stockists of Wabco, Cummins, Raufoss, Fleetguard and Valvoline.



Tel: +44 (0) 121 544 0951
e-mail: sales@majorsell.co.uk
www.majorsell.co.uk



Original part numbers are used for reference only. All parts offered are Majorsell brand and may not be of an original supply. Majorsell kit content may be different to the original. Check all applications. Check our web site for suitability of these and other parts, or contact us directly.

Table of Contents

Intro Section	5	411 154 000 0	17	911 153 003 0	33	912 510 002 0	49
		411 154 001 0	17	911 153 010 0	33	912 510 003 0	49
MAN SERIES		411 154 003 0	18	911 153 510 0	34	912 510 103 0	49
		411 553 000 0	18	911 153 520 0	34	912 510 104 0	50
51540007079	5	411 553 001 0	18	911 153 524 0	34	912 510 105 0	50
51541006007	5	411 553 003 0	19	911 153 530 0	35	912 510 106 0	50
51541007028	5	412 352 002 0	20	911 153 608 0	35	912 510 200 0	51
51541007033	6	412 352 003 0	20	911 153 938 0	35	912 510 201 0	51
51541007190	6	412 352 004 0	20	911 154 500 0	36	912 510 300 0	51
		412 352 005 0	21	911 154 510 0	36	912 512 001 0	52
MERC SERIES		412 352 008 0	21	911 154 513 0	36	912 512 004 0	52
		412 352 010 0	21	911 154 515 0	37	912 512 006 0	52
AXOR ACTROS	7	412 352 011 0	22	911 501 016 0	37	912 512 029 0	53
AXOR ATEGO	7	412 352 014 0	22	911 501 059 0	37	912 514 001 0	53
ACTROS EVOBUS	7	412 352 016 0	22	911 503 051 0	38	912 514 003 0	53
OM501 (1 of 2)	8	412 352 020 0	23	911 504 051 0	38	912 514 004 0	54
OM501 (2 of 2)	8	412 352 025 0	23	911 504 052 0	38	912 514 009 0	54
		412 352 026 0	23	911 504 056 0	39	912 518 003 0	54
WABCO SERIES		412 352 027 0	24	911 504 060 0	39	912 518 005 0	55
		412 352 030 0	24	911 504 501 0	39	912 518 107 0	55
411 034 501 0	9	412 442 000 0	24	911 504 503 0	40	912 518 200 0	55
411 043 805 0	9	412 442 001 0	25	911 504 504 0	40	912 518 202 0	56
411 140 000 0	9	412 636 000 0	25	911 504 506 0	40	912 518 206 0	56
411 140 845 0	10	412 636 001 0	25	911 505 150 0	41	912 518 207 0	56
411 141 001 0	10	412 636 003 0	26	911 505 151 0	41		
411 141 640 0	10	412 704 000 0	26	911 505 154 0	41	REPAIR KITS	
411 141 805 0	11	412 704 001 0	26	911 506 054 0	42	A67RK001	57
411 141 845 0	11	412 704 004 0	27	911 506 505 0	42	A67RK004	57
411 142 681 0	11	412 704 005 0	27	911 514 001 0	42	A67RK005	57
411 142 850 0	12	412 704 006 0	27	911 515 016 0	43	A67RK017	58
411 143 805 0	12	412 704 008 0	28	911 516 010 0	43	A67RK019	58
411 143 844 0	12	412 704 009 0	28	911 553 003 0	43	A67RK021	58
411 143 881 0	13	412 704 013 0	28	911 553 007 0	44	A67RK024	59
411 144 003 0	13	412 704 014 0	29	911 553 100 0	44	A67RK025	59
411 145 507 0	13	412 704 015 0	29	911 553 101 0	44	A67RK026	59
411 145 512 0	14	412 704 016 0	29	911 553 103 0	45	A67RK035	60
411 146 001 0	14	412 704 018 0	30	911 553 105 0	45	A67RK036	60
411 146 003 0	14	412 704 019 0	30	911 553 200 0	45	A67RK037	60
411 147 058 0	15	911 141 001 0	31	911 553 203 0	46	A67RK038	61
411 147 059 0	15	911 142 000 0	31	912 112 000 0	47	A67RK047	61
411 151 000 0	15	911 145 002 0	31	912 112 001 0	47	A67RK049	61
411 151 003 0	16	911 145 050 0	32	912 116 000 0	47	A67RK050	62
411 151 004 0	16	911 145 060 0	32	912 117 000 0	48	A67RK053	62
411 151 008 0	16	911 145 560 0	32	912 210 000 0	48	A67RK054	62
411 151 009 0	17	911 146 003 0	33	912 510 001 0	48		

Table of Contents

A67RK055	63	A67RK127	77
A67RK056	63	A67RK128	78
A67RK057	63	A67RK129	78
A67RK058	64	A67RK130	78
A67RK059	64	A67RK131	78
A67RK060	64	A67RK132	79
A67RK061	65	220034V	79
A67RK062	65	220056V	79
A67RK063	65		
A67RK065	66		
A67RK066	66		
A67RK067	66		
A67RK068	67		
A67RK069	67		
A67RK070	67		
A67RK072	68		
A67RK073	68		
A67RK074	69		
A67RK082	69		
A67RK083	69		
A67RK084	70		
A67RK085	70		
A67RK087	70		
A67RK088	71		
A67RK089	71		
A67RK090	71		
A67RK091	72		
A67RK092	72		
A67RK093	72		
A67RK095	73		
A67RK096	73		
A67RK097	73		
A67RK098	74		
A67RK109	74		
A67RK112	74		
A67RK113	74		
A67RK114	75		
A67RK115	75		
A67RK116	75		
A67RK117	76		
A67RK118	76		
A67RK119	76		
A67RK123	77		
A67RK124	77		
A67RK126	77		

MAN SERIES

		MAJORSELL PARTS FOR: 51540007079				MAJORSELL REBUILD: 23A004R		
		Users						
		OE						
Bore	Drive	Cooling	Weight	Mount	Lube	Water Port	Air Inlet	Air Delivery
90 mm	Through	Water	28 kg	Side	Engine Oil	M22	M26	M26
Repair Kits	Full Kit	Head Kit	Gasket Kit	Valve Kit	Valve Plate	Cooling Plate		
	A67RK004	A67RK004A	A67RK004B	A67RK004C	A67RK004V			
Piston	Std	0.25 mm	0.50 mm	0.75 mm	1.00 mm			
	020118	020230	020119	020231	020120			
Rings	A67RK007	A67RK099	A67RK009	A67RK100	A67RK011			
Head	220025	220022 (Comp)			Rear end Cover		Conn Rod	220016 (2)
Crankshaft	220053				Front end Cover			
Bolts	140143 (8)	140132 (2)	140138 (10)	140023 (3)	140098 (4)	140127 (3)	140138 (3)	140288 (8)
Other Parts	Rear Bush	Inserts	Gasket	Cylinder	Piston & Cylinder Kit		Rear Blank Cap	Front Gear
	050218	050164 (2)	010411	020043L	020043		220425	220181

* 23 Teeth Gear

		MAJORSELL PARTS FOR: 51541006007				MAJORSELL REBUILD: 23A012R		
		Users	MAN					
		OE						
Bore	Drive	Cooling	Weight	Mount	Lube	Water Port	Air Inlet	Air Delivery
90 mm	Through	Water	28 kg	Side	Engine Oil	M22	M26	M26
Repair Kits	Full Kit	Head Kit	Gasket Kit	Valve Kit	Valve Plate	Cooling Plate		
	A67RK113	A67RK113A	A67RK113B	A67RK113C	A67RK061V	A67RK061CP		
Piston	Std	0.25 mm	0.50 mm	0.75 mm	1.00 mm			
	020118		020119		020120			
Rings	A67RK007		A67RK009		A67RK011			
Head	220252	220108 (Comp)			Rear end Cover		Conn Rod	220016
Crankshaft	220778	140013 (Pin)			Front end Cover			
Bolts	140149 (8)	140131 (2)	140138 (10)	140127 (3)	140138 (3)			
Other Parts	Rear Bush	Inserts	Gasket	Cylinder	Piston & Cylinder Kit		Front Gear	Crankcase
	050218	050164 (2)	010411	020043L	020043		220536	220094

* 23 Teeth Gear

		MAJORSELL PARTS FOR: 51541007028				MAJORSELL REBUILD: 23A011R		
		Users	MAN					
		OE	TGA Euro 2					
Bore	Drive	Cooling	Weight	Mount	Lube	Water Port	Air Inlet	Air Delivery
90 mm	Through	Water	28 kg	Side	Engine Oil	M22	M26	M26
Repair Kits	Full Kit	Head Kit	Gasket Kit	Valve Kit	Valve Plate	Cooling Plate		
	A67RK113	A67RK113A	A67RK113B	A67RK113C	A67RK061V	A67RK061CP		
Piston	Std	0.25 mm	0.50 mm	0.75 mm	1.00 mm			
	020118		020119		020120			
Rings	A67RK007		A67RK009		A67RK011			
Head		220108 (Comp)			Rear end Cover		Conn Rod	220016
Crankshaft	220095	140013 (Pin)			Front end Cover			
Bolts	140149 (8)	140131 (2)	140138 (10)	140127 (3)	140138 (3)			
Other Parts	Front Gear	Front Bearing	Inserts	C Shaft Gear	Piston & Cylinder Kit		Gasket	Cylinder
	220181	050218	050164 (2)	220181	020043		010411	020043L

* 220181 has 25 Teeth

MAN SERIES

		MAJORSELL PARTS FOR: 51541007033				MAJORSELL REBUILD: 23A024R		
		Users	MAN					
		OE						
Bore	Drive	Cooling	Weight	Mount	Lube	Water Port	Air Inlet	Air Delivery
90 mm	Through	Water	28 kg	Side	Engine Oil	M22	M26	M26
Repair Kits	Full Kit	Head Kit	Gasket Kit	Valve Kit	Valve Plate	Cooling Plate		
	A67RK061	A67RK061A	A67RK061B	A67RK061C	A67RK061V	A67RK061CP		
Piston	Std	0.25 mm	0.50 mm	0.75 mm	1.00 mm			
	020118	020230	020119	020231	020232			
Rings	A67RK007	A67RK099	A67RK009	A67RK100	A67RK011			
Head	220252	220108 (Comp)			Rear end Cover		Conn Rod	220016
Crankshaft	220011	140008 (Pin)			Front end Cover	220175		
Bolts	140149 (4)	140131 (1)	140138 (5)	140127 (3)	140138 (3)	140138 (4)	140288 (4)	
Other Parts	Rear Bush	Inserts	Gasket	Cylinder	Piston & Cylinder Kit		Front Gear	Seal
	050194	050164	010411	020043L	020043		220828	RM0795-30V

* 23 Teeth Gear

		MAJORSELL PARTS FOR: 51541007190				MAJORSELL REBUILD: 23A019R		
		Users	MAN					
		OE	51541007190					
Bore	Drive	Cooling	Weight	Mount	Lube	Water Port	Air Inlet	Air Delivery
100 mm	Through	Water	29 kg	Base	Engine Oil	M22	M26	M26
Repair Kits	Full Kit	Head Kit	Gasket Kit	Valve Kit	Valve Plate	Cooling Plate		
	A67RK097	A7RK097A	A67RK097B	A67RK097C	A67RK097V	A67RK097CP		
Piston	Std	0.25 mm	0.50 mm	0.75 mm	1.00 mm			
	020143	020204	020144	020205	020145			
Rings	A67RK043	A67RK103	A67RK044	A67RK104	A67RK045			
Head	220251 (2)	220596 (Comp)(2)			Rear end Cover		Conn Rod	220074 (2)
Crankshaft	220328				Front end Cover			
Bolts	140305 (8)	140131 (2)	140138 (10)	140153 (3)	140199 (3)			
Other Parts	Rear Bush	Cylinder	Cylinder & Piston					
	050218	020166L (2)	020166 (2)					

MERCEDES SERIES

		MAJORSELL PARTS FOR: AXOR ACTROS				MAJORSELL REBUILD:		
		Users	MERCEDES					
		OE						
Bore	Drive	Cooling	Weight	Mount	Lube	Water Port	Air Inlet	Air Delivery
85 mm	Non-Through	Water		Flange				
Repair Kits	Full Kit	Head Kit	Gasket Kit	Valve Kit	Ess Kit	Cooling Plate		
	A67RK068	A67RK068A	A67RK068B	A67RK065C	A67RK073D	A67RK068CP		
Piston	Std	0.25 mm	0.50 mm	0.75 mm	1.00 mm			
	020023	020179	020024	020189	020025			
Rings	A69RK028	A69RK069	A69RK054	A69RK070	A69RK055			
Head					Rear end Cover	220227	Conn Rod	220224
Crankshaft	220229	140016 (Nut)			Front end Cover			
Bolts	140139 (2)	140143 (4)	140124 (4)					
Other Parts	Front Bush	O Ring	Base Plate					
	050186	RM1250-30V	220058					

		MAJORSELL PARTS FOR: AXOR ATEGO				MAJORSELL REBUILD:		
		Users	MERCEDES					
		OE						
Bore	Drive	Cooling	Weight	Mount	Lube	Water Port	Air Inlet	Air Delivery
85 mm		Water		Flange				
Repair Kits	Full Kit	Head Kit	Gasket Kit	Valve Kit	Ess Kit	Cooling Plate		
	A67RK068	A67RK068A	A67RK068B	A67RK065C	A67RK073D	A67RK068CP		
Piston	Std	0.25 mm	0.50 mm	0.75 mm	1.00 mm			
	020023	020179	020024	020189	020025			
Rings	A69RK028	A69RK069	A69RK054	A69RK070	A69RK055			
Head					Rear end Cover	220227	Conn Rod	220224
Crankshaft	220229	140016 (Nut)			Front end Cover			
Bolts	140139 (2)	140143 (4)	140124 (4)					
Other Parts	Front Bush	O Ring	Base Plate					
	050186	RM1250-30V	220058					

		MAJORSELL PARTS FOR: ACTROS EVOBUS				MAJORSELL REBUILD:		
		Users	MERCEDES					
		OE						
Bore	Drive	Cooling	Weight	Mount	Lube	Water Port	Air Inlet	Air Delivery
90 mm		Water						
Repair Kits	Full Kit	Head Kit	Gasket Kit	Valve Kit	Valve Plate	Cooling Plate		
	A67RK096	A67RK096A	A67RK096B	A67RK096C	A67RK096V			
Piston	Std	0.25 mm	0.50 mm	0.75 mm	1.00 mm			
	020143	020204	020144	020205	020145			
Rings	A67RK043	A67RK103	A67RK044	A67RK104	A67RK045			
Head	220388	220387 (Comp)			Rear end Cover		Conn Rod	
Crankshaft					Front end Cover			
Bolts								
Other Parts	Liner & Piston							
	020167							

MERCEDES SERIES

		MAJORSELL PARTS FOR: OM501 (1 of 2)				MAJORSELL REBUILD:		
		Users	MERCEDES					
		OE						
Bore	Drive	Cooling	Weight	Mount	Lube	Water Port	Air Inlet	Air Delivery
100 mm		Water						
Repair Kits	Full Kit	Head Kit	Gasket Kit	Valve Kit	Valve Plate	Cooling Plate		
	A67RK021	A67RK021A			220034V			
Piston	Std	0.25 mm	0.50 mm	0.75 mm	1.00 mm			
	020143	020204	020144	020205	020145			
Rings	A67RK043	A67RK103	A67RK044	A67RK104	A67RK045			
Head	220112	220034 (Comp)			Rear end Cover		Conn Rod	220017
Crankshaft	220012				Front end Cover			
Bolts								
Other Parts	Liner & Piston							
	020167							

		MAJORSELL PARTS FOR: OM501 (2 of 2)				MAJORSELL REBUILD:		
		Users	MERCEDES					
		OE						
Bore	Drive	Cooling	Weight	Mount	Lube	Water Port	Air Inlet	Air Delivery
100 mm		Water						
Repair Kits	Full Kit	Head Kit	Gasket Kit	Valve Kit	Valve Plate	Cooling Plate		
	A67RK021	A67RK021A			220056V			
Piston	Std	0.25 mm	0.50 mm	0.75 mm	1.00 mm			
	020143	020204	020144	020205	020145			
Rings	A67RK043	A67RK103	A67RK044	A67RK104	A67RK045			
Head	220056A	220056 (Comp)			Rear end Cover		Conn Rod	220017
Crankshaft	220012				Front end Cover			
Bolts								
Other Parts	Liner & Piston							
	020167							

WABCO SERIES

		MAJORSELL PARTS FOR: 411 034 501 0				MAJORSELL REBUILD: 67A011R		
		Users	MERCEDES	DAF				
		OE	0011315201					
Bore	Drive	Cooling	Weight	Mount	Lube	Water Port	Air Inlet	Air Delivery
90 mm	Through	Air		Base	Engine Oil		M26	M26
Repair Kits	Full Kit	Head Kit	Gasket Kit	Valve Kit	Valve Plate	Cooling Plate		
	A67RK001	A67RK001A	A67RK001B	A67RK024C	A67RK001V			
Piston	Std	0.25 mm	0.50 mm	0.75 mm	1.00 mm			
Rings	A67RK007		A67RK009		A67RK011			
Head	220081	220116 (Comp)			Rear end Cover	220119	Conn Rod	220079
Crankshaft	220080	140015 (Nut)			Front end Cover	220120		
Bolts								
Other Parts	Front Bush	Rear Bearing	Liner & Piston	Inserts	Liner			
	050158	6206	020223K	050159	020223			

		MAJORSELL PARTS FOR: 411 043 805 0				MAJORSELL REBUILD: 67A090R		
		Users	IVECO					
		OE	1173860	01261657				
Bore	Drive	Cooling	Weight	Mount	Lube	Water Port	Air Inlet	Air Delivery
90 mm	Non-Through	Air	11 kg	Base	Engine Oil		M26	M26
Repair Kits	Full Kit	Head Kit	Gasket Kit	Valve Kit	Valve Plate	Cooling Plate		
	A67RK001	A67RK001A	A67RK001B	A67RK001C	A67RK001V			
Piston	Std	0.25 mm	0.50 mm	0.75 mm	1.00 mm			
Rings	A67RK007		A67RK009		A67RK011			
Head	220081	220116 (Comp)			Rear end Cover		Conn Rod	
Crankshaft		140015 (Nut)			Front end Cover			
Bolts	140193 (4)	140103 (4)	140193 (4)	140103 (4)	140155 (4)	140103 (4)		
Other Parts	Rear Bush	Inserts	Liner & Piston	Liner	Rear Bush	Flange Ring		
	050158	050159	020223K	020223	050192	RM0880-30V		

		MAJORSELL PARTS FOR: 411 140 000 0				MAJORSELL REBUILD: 67A012R		
		Users	DAF					
		OE	1517932					
Bore	Drive	Cooling	Weight	Mount	Lube	Water Port	Air Inlet	Air Delivery
75 mm	Non-Through	Air	10 kg	Base	Engine Oil		M26	M26
Repair Kits	Full Kit	Head Kit	Gasket Kit	Valve Kit	Valve Plate	Cooling Plate		
	A67RK035	A67RK035A	A67RK035B	A67RK035C	A67RK035V			
Piston	Std	0.25 mm	0.50 mm	0.75 mm	1.00 mm			
	020067	020176	020076	020196	020095			
Rings	A67RK013	A67RK101	A67RK014	A67RK102	A67RK023			
Head					Rear end Cover	220187	Conn Rod	
Crankshaft	220064	140015 (Nut)			Front end Cover			
Bolts	140131 (4)	140138 (4)	140198 (4)					
Other Parts	Front Bush	Rear Bush	O Ring	Oil Seal	Base Plate			
	050158	050189	RM0880-30V	110034	080038 (2)			

WABCO SERIES

		MAJORSELL PARTS FOR: 411 140 845 0				MAJORSELL REBUILD: 67A094R		
		Users						
		OE						
Bore	Drive	Cooling	Weight	Mount	Lube	Water Port	Air Inlet	Air Delivery
75 mm	Non-Through	Air		Base	Engine		26 mm	26 mm
Repair Kits	Full Kit	Head Kit	Gasket Kit	Valve Kit	Valve Plate	Cooling Plate		
	A67RK035	A67RK035A	A67RK035B	A67RK035C	A67RK055V			
Piston	Std	0.25 mm	0.50 mm	0.75 mm	1.00 mm			
	020067	020176	020076	020196	020095			
Rings	A67RK013	A67RK101	A67RK014	A67RK102	A67RK023			
Head		220284			Rear end Cover		Conn Rod	
Crankshaft		140015 (Nut)			Front end Cover			
Bolts	140131 (4)	140138 (4)	140198 (4)					
Other Parts	Front Bush	Rear Bush	F Cover Seal	Sump Cover	Oil Seal			
	050195	050189	RM0880-30V	080038 (2)	110034			

		MAJORSELL PARTS FOR: 411 141 001 0				MAJORSELL REBUILD: 67A013R		
		Users	DAF					
		OE	1505909					
Bore	Drive	Cooling	Weight	Mount	Lube	Water Port	Air Inlet	Air Delivery
75 mm	Non-Through	Air	9 kg	Base	Engine Oil		M26	M26
Repair Kits	Full Kit	Head Kit	Gasket Kit	Valve Kit	Valve Plate	Cooling Plate		
	A67RK035	A67RK035A	A67RK035B	A67RK035C	A67RK035V			
Piston	Std	0.25 mm	0.50 mm	0.75 mm	1.00 mm			
	020067	020176	020076	020196	020095			
Rings	A67RK013	A67RK101	A67RK014	A67RK102	A67RK023			
Head	220284	220283 (Comp)			Rear end Cover	220187	Conn Rod	220063
Crankshaft	220601	140015 (Nut)			Front end Cover	220438		
Bolts	140131 (4)	140138 (4)	140198 (4)					
Other Parts	Front bush	Rear Bush	Speedy Sleeve	Base Plate				
	050158	050189	050002	080038 (2)				

		MAJORSELL PARTS FOR: 411 141 640 0				MAJORSELL REBUILD: 67A022R		
		Users	MERCEDES					
		OE	A00313150					
Bore	Drive	Cooling	Weight	Mount	Lube	Water Port	Air Inlet	Air Delivery
75 mm	Non-Through	Air	9 kg	Base	Engine Oil		M26	M26
Repair Kits	Full Kit	Head Kit	Gasket Kit	Valve Kit	Valve Plate	Cooling Plate		
	A67RK035	A67RK035A	A67RK035B	A67RK035C	A67RK055V			
Piston	Std	0.25 mm	0.50 mm	0.75 mm	1.00 mm			
	020067	020176	020076	020196	020095			
Rings	A67RK013	A67RK101	A67RK014	A67RK102	A67RK023			
Head	220284	220283 (Comp)			Rear end Cover		Conn Rod	
Crankshaft		140015 (Nut)			Front end Cover			
Bolts	140131 (4)	140138 (4)	140198 (4)	140124 (4)				
Other Parts	Front Bush	Rear Bush	Inserts	Base Plate	O Ring			
	050158	050189	050159 (2)	080038 (2)	RM0570-30V			

WABCO SERIES

		MAJORSELL PARTS FOR: 411 141 805 0				MAJORSELL REBUILD: 67A091R		
		Users	DAF	IVECO	VOLVO			
		OE	1505913	01173862	0022820701			
Bore	Drive	Cooling	Weight	Mount	Lube	Water Port	Air Inlet	Air Delivery
75 mm	Non-Through	Air	9 kg	Base	Engine Oil		M26	M26
Repair Kits	Full Kit	Head Kit	Gasket Kit	Valve Kit	Valve Plate	Cooling Plate		
	A67RK035	A67RK035A	A67RK035B	A67RK035C	A67RK035V			
Piston	Std	0.25 mm	0.50 mm	0.75 mm	1.00 mm			
	020067	020176	020076	020196	020095			
Rings	A67RK013	A67RK101	A67RK014	A67RK102	A67RK023			
Head					Rear end Cover	220187	Conn Rod	
Crankshaft		140015 (Nut)			Front end Cover			
Bolts	140131 (4)	140138 (4)	140198 (4)					
Other Parts	Front Bush	Rear Bush	Speedy Sleeve	Inserts	Base Plate			
	050158	050189	050002	050159	080038 (2)			

		MAJORSELL PARTS FOR: 411 141 845 0				MAJORSELL REBUILD: 67A098R		
		Users	DAF	IVECO				
		OE	1518582	01173867	42522657			
Bore	Drive	Cooling	Weight	Mount	Lube	Water Port	Air Inlet	Air Delivery
75 mm	Non-Through	Air	9 kg	Base	Engine Oil		M26	M26
Repair Kits	Full Kit	Head Kit	Gasket Kit	Valve Kit	Valve Plate	Cooling Plate		
	A67RK035	A67RK035A	A67RK035B	A67RK035C	A67RK035V			
Piston	Std	0.25 mm	0.50 mm	0.75 mm	1.00 mm			
	020067	020176	020076	020196	020095			
Rings	A67RK013	A67RK101	A67RK014	A67RK102	A67RK023			
Head					Rear end Cover	220187	Conn Rod	
Crankshaft		140015 (Nut)			Front end Cover			
Bolts	140131 (4)	140138 (4)	140198 (4)					
Other Parts	Front Bush	Rear Bush	Speedy Sleeve	Inserts	Base Plate			
	050158	050189	050002	050159	080038 (2)			

		MAJORSELL PARTS FOR: 411 142 681 0				MAJORSELL REBUILD: 67A148R		
		Users	EVOBUS					
		OE						
Bore	Drive	Cooling	Weight	Mount	Lube	Water Port	Air Inlet	Air Delivery
90 mm	Non-Through	Water	11 kg	Base	Engine Oil	M14	M26	M26
Repair Kits	Full Kit	Head Kit	Gasket Kit	Valve Kit	Valve Plate	Cooling Plate		
	A67RK004	A67RK004A	A67RK004B	A67RK004C	A67RK004V			
Piston	Std	0.25 mm	0.50 mm	0.75 mm	1.00 mm	+1.50 mm		
	020068	020197	020069	020198	020070	020071		
Rings	A67RK007	A67RK099	A67RK009	A67RK100	A67RK011			
Head	220025	220022 (Comp)			Rear end Cover	220859	Conn Rod	220437
Crankshaft	220601	140015 (Nut)			Front end Cover	220438		
Bolts	140143 (4)	140132 (1)	140138 (5)	140198 (4)	140124 (4)			
Other Parts	Rear Bush	Front Bush	Inserts	Oil Seal	O Ring	Base Plate	R Cov Seal	
	050189	050292	050159	110034	RM0880-30V	080038 (2)	RM0570-30V	

WABCO SERIES

		MAJORSELL PARTS FOR: 411 142 850 0				MAJORSELL REBUILD: 67A069R		
		Users	MERCEDES					
		OE	0041318301					
Bore	Drive	Cooling	Weight	Mount	Lube	Water Port	Air Inlet	Air Delivery
90 mm	Non-Through	Water	11 kg	Side	Engine Oil	M22	M26	M26
Repair Kits	Full Kit	Head Kit	Gasket Kit	Valve Kit	Valve Plate	Cooling Plate		
	A67RK004	A67RK004A	A67RK004B	A67RK004C	A67RK004V			
Piston	Std	0.25 mm	0.50 mm	0.75 mm	1.00 mm	+1.50 mm		
	020068	020197	020069	020198	020070	020071		
Rings	A67RK007	A67RK099	A67RK009	A67RK100	A67RK011			
Head	220025	220022 (Comp)			Rear end Cover		Conn Rod	
Crankshaft		140015 (Nut)			Front end Cover	220187		
Bolts	140128 (4)	140132 (1)	140138 (5)	140138 (4)	140124 (4)			
Other Parts	Front Bush	Oil Seal	Base Plate	Cover Seal				
	050292	110034	080038 (2)	RM0880-30V				

		MAJORSELL PARTS FOR: 411 143 805 0				MAJORSELL REBUILD: 67A087R		
		Users	RVI	IVECO	DAF	IKARUS		
		OE	0001119046	01173860	01174472	01173852	01261657	1517936
Bore	Drive	Cooling	Weight	Mount	Lube	Water Port	Air Inlet	Air Delivery
90 mm	Non-Through	Air	10 kg	Base	Engine Oil		M26	M26
Repair Kits	Full Kit	Head Kit	Gasket Kit	Valve Kit	Valve Plate	Cooling Plate		
	A67RK024	A67RK024A	A67RK024B	A67RK024C	A67RK024V			
Piston	Std	0.25 mm	0.50 mm	0.75 mm	1.00 mm	+1.50 mm		
	020068	020197	020069	020198	020070	020071		
Rings	A67RK007	A67RK099	A67RK009	A67RK100	A67RK011			
Head	220439	220440 (Comp)			Rear end Cover	220187	Conn Rod	220437
Crankshaft	220436	140015 (Nut)			Front end Cover	220438		
Bolts	140131 (4)	140167 (1)	140138 (4)	140198 (4)				
Other Parts	Front Bush	Rear Bush	Base Plate	Inserts	Seal			
	050292	050189	080038 (2)	050159	RM0880-30V			

		MAJORSELL PARTS FOR: 411 143 844 0				MAJORSELL REBUILD: 67A095R		
		Users	DEUTZ	IVECO	TEREX	KOMATS		
		OE	01173858	42522655	43385540			
Bore	Drive	Cooling	Weight	Mount	Lube	Water Port	Air Inlet	Air Delivery
90 mm	Non-Through	Air	10 kg	Base	Engine Oil		M26	M26
Repair Kits	Full Kit	Head Kit	Gasket Kit	Valve Kit	Valve Plate	Cooling Plate		
	A67RK024	A67RK024A	A67RK024B	A67RK024C	A67RK024V			
Piston	Std	0.25 mm	0.50 mm	0.75 mm	1.00 mm	+1.50 mm		
	020068	020197	020069	020198	020070	020071		
Rings	A67RK007	A67RK099	A67RK009	A67RK100	A67RK011			
Head	220439	220440 (Comp)			Rear end Cover	220187	Conn Rod	220437
Crankshaft	220436	140015 (Nut)			Front end Cover			
Bolts	140131 (4)	140167 (1)	140198 (4)	140138 (4)				
Other Parts	Front Bush	Rear Bush	Oil Seal	Base Plate	Inserts			
	050292	050189	110034	080038 (2)	050159			

WABCO SERIES

		MAJORSELL PARTS FOR: 411 143 881 0				MAJORSELL REBUILD: 67A089R		
		Users	FORD	EVOBUS				
		OE						
Bore	Drive	Cooling	Weight	Mount	Lube	Water Port	Air Inlet	Air Delivery
90 mm	Non-Through	Water	11 kg	Base	Engine Oil	M14	M26	M26
Repair Kits	Full Kit	Head Kit	Gasket Kit	Valve Kit	Valve Plate	Cooling Plate		
	A67RK004	A67RK004A	A67RK004B	A67RK004C	A67RK004V			
Piston	Std	0.25 mm	0.50 mm	0.75 mm	1.00 mm	+1.50 mm		
	020068	020197	020069	020198	020070	020071		
Rings	A67RK007	A67RK099	A67RK009	A67RK100	A67RK011			
Head	220025	220022 (Comp)			Rear end Cover	220187	Conn Rod	220437
Crankshaft	220436	140015 (Nut)			Front end Cover			
Bolts	140143 (4)	140132 (1)	140138 (5)	140198 (4)				
Other Parts	Front Bush	Rear Bush	Cover Seal	Inserts	Base Plate			
	050292	050189	RM0880-30V	050159	080038 (2)			

		MAJORSELL PARTS FOR: 411 144 003 0				MAJORSELL REBUILD: 67A088R		
		Users	IVECO	DEUTZ				
		OE	01180386					
Bore	Drive	Cooling	Weight	Mount	Lube	Water Port	Air Inlet	Air Delivery
75 mm	Non-Through	Air	10 kg	Flange	Engine Oil		M26	M26
Repair Kits	Full Kit	Head Kit	Gasket Kit	Valve Kit	Valve Plate	Cooling Plate		
	A67RK035	A67RK035A	A67RK035B	A67RK035C	A67RK035V			
Piston	Std	0.25 mm	0.50 mm	0.75 mm	1.00 mm			
	020067	020176	020076	020196	020095			
Rings	A67RK013	A67RK101	A67RK014	A67RK102	A67RK023			
Head	220284	220283 (Comp)			Rear end Cover	220187	Conn Rod	
Crankshaft		140016 (Nut)			Front end Cover			
Bolts	140131 (4)	140150 (4)	140138 (4)					
Other Parts	Front Bush	Rear Bush	O Ring	Base Plate				
	050195	050189	RM1250-30V	080038 (2)				

		MAJORSELL PARTS FOR: 411 145 507 0				MAJORSELL REBUILD: 67A051R		
		Users	MAN	NEOPLAN				
		OE	J1541017201	51541017201	51541017190	51541017197	51541017204	51541019204
Bore	Drive	Cooling	Weight	Mount	Lube	Water Port	Air Inlet	Air Delivery
75 mm	Through	Water	11.5 kg	Flange	Engine Oil	M22	M26	M26
Repair Kits	Full Kit	Head Kit	Gasket Kit	Valve Kit	Valve Plate	Cooling Plate		
	A67RK055	A67RK055A	A67RK055B	A67RK035C	A67RK055V			
Piston	Std	0.25 mm	0.50 mm	0.75 mm	1.00 mm			
	020067	020176	020076	020196	020095			
Rings	A67RK013	A67RK101	A67RK014	A67RK102	A67RK023			
Head	220293	220292 (Comp)			Rear end Cover		Conn Rod	220884
Crankshaft	220883	140016 (Nut)			Front end Cover			
Bolts	140143 (4)	140138 (4)	140124 (4)	140103 (4)				
Other Parts	Front Bush	Rear Bush	Inserts	Base Plate	F Flange Seal	F Cov Seal		
	050158	050197	050159	080038 (2)	RM0780-30S	RM0680-40		

WABCO SERIES

		MAJORSELL PARTS FOR: 411 145 512 0				MAJORSELL REBUILD: 67A052R		
		Users						
		OE						
Bore	Drive	Cooling	Weight	Mount	Lube	Water Port	Air Inlet	Air Delivery
75 mm	Through	Air	10 kg	Flange	Engine Oil		26 mm	26 mm
Repair Kits	Full Kit	Head Kit	Gasket Kit	Valve Kit	Valve Plate	Cooling Plate		
	A67RK055	A67RK055A	A67RK055B	A67RK035C	A67RK035V			
Piston	Std	0.25 mm	0.50 mm	0.75 mm	1.00 mm			
	020067	020176	020076	020196	020095			
Rings	A67RK013	A67RK101	A67RK014	A67RK102	A67RK023			
Head	220284	220283 (Comp)			Rear end Cover		Conn Rod	
Crankshaft		140016 (Nut)			Front end Cover			
Bolts	140143 (4)	140138 (4)	140124 (4)	140138 (2)				
Other Parts	Front Bush	Rear Bush	Thrust Washer	Inserts	Base Plate			
	050158	050197	050191	050159	080038 (2)			

		MAJORSELL PARTS FOR: 411 146 001 0				MAJORSELL REBUILD:		
		Users						
		OE						
Bore	Drive	Cooling	Weight	Mount	Lube	Water Port	Air Inlet	Air Delivery
90 mm								
Repair Kits	Full Kit	Head Kit	Gasket Kit	Valve Kit	Valve Plate	Cooling Plate		
	A67RK083	A67RK083A	A67RK083B	A67RK083C				
Piston	Std	0.25 mm	0.50 mm	0.75 mm	1.00 mm	+1.50 mm		
Rings	A67RK007	A67RK099	A67RK009	A67RK100	A67RK011			
Head					Rear end Cover		Conn Rod	
Crankshaft					Front end Cover			
Bolts								
Other Parts								

		MAJORSELL PARTS FOR: 411 146 003 0				MAJORSELL REBUILD: 67A096R		
		Users		IVECO	DEUTZ			
		OE		04428408				
Bore	Drive	Cooling	Weight	Mount	Lube	Water Port	Air Inlet	Air Delivery
90 mm	Non-Through	Air	14 kg	Flange	Engine Oil		M26	M26
Repair Kits	Full Kit	Head Kit	Gasket Kit	Valve Kit	Valve Plate	Cooling Plate		
	A67RK083	A67RK083A	A67RK083B	A67RK083C	A67RK024V			
Piston	Std	0.25 mm	0.50 mm	0.75 mm	1.00 mm	+1.50 mm		
	020068	020197	020069	020198	020070	020071		
Rings	A67RK007	A67RK099	A67RK009	A67RK100	A67RK011			
Head	220439	220440 (Comp)			Rear end Cover		Conn Rod	
Crankshaft		140016 (Nut)			Front end Cover			
Bolts	140131 (4)	140167 (1)	140138 (5)	140150 (4)	140193 (4)	140138 (4)		
Other Parts	Front Bush	Rear Bush	O Ring	Base Plate				
	050211	050189	RM1250-30V	080038 (2)				

WABCO SERIES

		MAJORSELL PARTS FOR: 411 147 058 0				MAJORSELL REBUILD: 67A151R		
		Users	DAF	NEOPLAN				
		OE	0285001	010170135				
Bore	Drive	Cooling	Weight	Mount	Lube	Water Port	Air Inlet	Air Delivery
90 mm	Non-Through	Water	12 kg	Flange	Engine Oil	M22	M26	M26
Repair Kits	Full Kit	Head Kit	Gasket Kit	Valve Kit	Valve Plate	Cooling Plate		
	A67RK004	A67RK004A	A67RK004B	A67RK024C	A67RK024V			
Piston	Std	0.25 mm	0.50 mm	0.75 mm	1.00 mm	+1.50 mm		
	020068	020197	020069	020198	020070	020071		
Rings	A67RK007	A67RK099	A67RK009	A67RK100	A67RK011			
Head	220025				Rear end Cover		Conn Rod	220437
Crankshaft		140016 (Nut)			Front end Cover			
Bolts	140143 (4)	140130 (1)	140138 (5)	140193 (4)	140138 (4)			
Other Parts	Front Bush	Rear Bush	Inserts	Base Plate	Thrust Washer	Flange Seal		
	050292	050189	050159	080038 (2)	050191	RM0800-30V		

		MAJORSELL PARTS FOR: 411 147 059 0				MAJORSELL REBUILD: 67A036R		
		Users	DAF	DENNIS	FODEN	SEDDON		
		OE	FBU2080	1505267				
Bore	Drive	Cooling	Weight	Mount	Lube	Water Port	Air Inlet	Air Delivery
90 mm	Through	Water	13 kg	Flange	Engine Oil	M22	M26	M26
Repair Kits	Full Kit	Head Kit	Gasket Kit	Valve Kit	Valve Plate	Cooling Plate		
	A67RK053	A67RK053A	A67RK053B	A67RK024C	A67RK024V			
Piston	Std	0.25 mm	0.50 mm	0.75 mm	1.00 mm	+1.50 mm		
	020068	020197	020069	020198	020070	020071		
Rings	A67RK007	A67RK099	A67RK009	A67RK100	A67RK011			
Head	220025				Rear end Cover		Conn Rod	
Crankshaft		140016 (Nut)			Front end Cover			
Bolts	140143 (4)	140130 (1)	140184 (3)	140176 (4)				
Other Parts	Front Bush	Rear Bush	Inserts	Base Plate	Thrust Washer			
	050195	050189	050159	080038 (2)	050191			

		MAJORSELL PARTS FOR: 411 151 000 0				MAJORSELL REBUILD: 67A054R		
		Users	DAF	SCANIA	MERCEDES			
		OE	1506773	9061300615	9061310501	1932577		
Bore	Drive	Cooling	Weight	Mount	Lube	Water Port	Air Inlet	Air Delivery
85 mm	Through	Water	10 kg	Flange	Engine Oil	M14	M26	M26
Repair Kits	Full Kit	Head Kit	Gasket Kit	Valve Kit	Valve Plate	Cooling Plate		
	A67RK057	A67RK057A	A67RK057B	A67RK057C	A67RK057V			
Piston	Std	0.25 mm	0.50 mm	0.75 mm	1.00 mm			
	020023	020179	020024	020189	020025			
Rings	A69RK028	A69RK069	A69RK054	A69RK070	A69RK055			
Head	220165	220145 (Comp)			Rear end Cover	220093	Conn Rod	220150
Crankshaft		140016 (Nut)			Front end Cover			
Bolts	140131 (4)	140144 (1)	140124 (4)	140103 (4)				
Other Parts	Front Bush	Front Gear	O Ring	Base Plate	Liner Sleeve			
	050212	220178	RM1180-30V	080038 (2)	020984			

WABCO SERIES

		MAJORSELL PARTS FOR: 411 151 003 0				MAJORSELL REBUILD: 67A067R			
		Users	MERCEDES						
		OE	9061300715	9061301115	9061302815				
Bore	Drive	Cooling	Weight	Mount	Lube	Water Port	Air Inlet	Air Delivery	
85 mm	Through	Water	10 kg	Flange	Engine Oil	M14	Manifold	M26	
Repair Kits	Full Kit	Head Kit	Gasket Kit	Valve Kit	Valve Plate	Cooling Plate			
	A67RK060	A67RK060A	A67RK060B	A67RK060C	A67RK060V				
Piston	Std	0.25 mm	0.50 mm	0.75 mm	1.00 mm				
	020023	020179	020024	020189	020025				
Rings	A69RK028	A69RK069	A69RK054	A69RK070	A69RK055				
Head	220158	220149 (Comp)			Rear end Cover	220093	Conn Rod	220593	
Crankshaft	220460	140203 (Nut)			Front end Cover				
Bolts	140131 (4)	140139 (1)	140199 (1)	140138 (4)	140124 (4)	140138 (4)			
Other Parts	Front Bush	Liner Sleeve	Base Plate	O Ring	Drive Gear				
	050212	020984	220058	RM1180-30V	220170				

		MAJORSELL PARTS FOR: 411 151 004 0				MAJORSELL REBUILD: 67A068R			
		Users	MAN						
		OE	51541017240	51541007005					
Bore	Drive	Cooling	Weight	Mount	Lube	Water Port	Air Inlet	Air Delivery	
85 mm	Through	Water	11.5 kg	Flange	Engine Oil	M14	M26	M26	
Repair Kits	Full Kit	Head Kit	Gasket Kit	Valve Kit	Valve Plate	Cooling Plate			
	A67RK059	A67RK059A	A67RK059B	A67RK059C	A67RK059V				
Piston	Std	0.25 mm	0.50 mm	0.75 mm	1.00 mm				
	020023	020179	020024	020189	020025				
Rings	A69RK028	A69RK069	A69RK054	A69RK070	A69RK055				
Head	220165	220413 (Comp)			Rear end Cover		Conn Rod		
Crankshaft	220995	140016 (Nut)			Front end Cover				
Bolts	140131 (4)	140144 (1)	140138 (5)						
Other Parts	Rear Bush	Base Plate	O Ring	O Ring	Liner Sleeve				
	050197	220058	RM0840-30V	RM0100-30S	020984				

		MAJORSELL PARTS FOR: 411 151 008 0				MAJORSELL REBUILD: 67A114R			
		Users	MERCEDES						
		OE	9061304115						
Bore	Drive	Cooling	Weight	Mount	Lube	Water Port	Air Inlet	Air Delivery	
85 mm	Through	Water	10 kg	Flange	Engine Oil	M14	Manifold	M26	
Repair Kits	Full Kit	Head Kit	Gasket Kit	Valve Kit	Valve Plate	Cooling Plate			
	A67RK060	A67RK060A	A67RK060B	A67RK060C	A67RK060V				
Piston	Std	0.25 mm	0.50 mm	0.75 mm	1.00 mm				
	020023	020179	020024	020189	020025				
Rings	A69RK028	A69RK069	A69RK054	A69RK070	A69RK055				
Head	220158	220149 (Comp)			Rear end Cover	220093	Conn Rod	220593	
Crankshaft	220460	140203 (Nut)			Front end Cover				
Bolts	140131 (4)	140139 (1)	140199 (1)	140138 (4)	140124 (4)	140138 (4)			
Other Parts	Front Bush	O Ring	Base Plate	O Ring	Drive Gear	Liner Sleeve			
	050212	RM0880-30V	220058	RM1180-30V	220178	020984			

WABCO SERIES

		MAJORSELL PARTS FOR: 411 151 009 0				MAJORSELL REBUILD: 67A170R		
		Users	MERCEDES					
		OE	4111510080	9061305415				
Bore	Drive	Cooling	Weight	Mount	Lube	Water Port	Air Inlet	Air Delivery
85 mm	Through	Water	10 kg	Flange	Engine Oil	M14	Manifold	M26
Repair Kits	Full Kit	Head Kit	Gasket Kit	Valve Kit	Valve Plate	Cooling Plate		
	A67RK098	A67RK098A	A67RK098B	A67RK098C	A67RK098V			
Piston	Std	0.25 mm	0.50 mm	0.75 mm	1.00 mm			
	020023	020179	020024	020189	020025			
Rings	A69RK028	A69RK069	A69RK054	A69RK070	A69RK055			
Head	220526	220525 (Comp)			Rear end Cover	220093	Conn Rod	220593
Crankshaft	220460(L/H)	140203 (Nut)			Front end Cover			
Bolts	140131 (4)	140139 (2)	140199 (2)	140138 (4)	140124 (4)	140138 (4)		
Other Parts	Front Bush	O Ring	Base Plate	O Ring	Drive Gear	Liner Sleeve		
	050212	RM0880-30V	220058	RM1180-30V	220178	020984		

		MAJORSELL PARTS FOR: 411 154 000 0				MAJORSELL REBUILD: 67A020R		
		Users	DAF	MERCEDES				
		OE	1517938	9061301215	9061302915			
Bore	Drive	Cooling	Weight	Mount	Lube	Water Port	Air Inlet	Air Delivery
85 mm	Through	Water	10 kg	Flange	Engine Oil			
Repair Kits	Full Kit	Head Kit	Gasket Kit	Valve Kit	Valve Plate	Cooling Plate		
	A67RK060	A67RK060A	A67RK060B	A67RK060C	A67RK060V			
Piston	Std	0.25 mm	0.50 mm	0.75 mm	1.00 mm			
	020023	020179	020024	020189	020025			
Rings	A69RK028	A69RK069	A69RK054	A69RK070	A69RK055			
Head	220158	220149 (Comp)			Rear end Cover	220093	Conn Rod	220150
Crankshaft	220377(L/H)	140203 (Nut)			Front end Cover			
Bolts	140131 (4)	140139 (1)	140199 (1)	140138 (4)	140124 (4)	140138 (4)		
Other Parts	Front Bush	Base Plate	O Ring	Liner Sleeve	Front Gear	R Cover Seal		
	050212	220058	RM1180-30V	020984	220178	RM0880-30V		

		MAJORSELL PARTS FOR: 411 154 001 0				MAJORSELL REBUILD:		
		Users	MERCEDES					
		OE						
Bore	Drive	Cooling	Weight	Mount	Lube	Water Port	Air Inlet	Air Delivery
85 mm	Through	Water	13.5 kg	Flange		M14	M26	M26
Repair Kits	Full Kit	Head Kit	Gasket Kit	Valve Kit	Valve Plate	Cooling Plate		
	A67RK089	A67RK089A	A67RK089B	A67RK063C				
Piston	Std	0.25 mm	0.50 mm	0.75 mm	1.00 mm			
	020023	020179	020024	020189	020025			
Rings	A69RK028	A69RK069	A69RK054	A69RK070	A69RK055			
Head					Rear end Cover		Conn Rod	
Crankshaft					Front end Cover			
Bolts								
Other Parts								

WABCO SERIES

		MAJORSELL PARTS FOR: 411 154 003 0				MAJORSELL REBUILD: 67A245R			
		Users	MERCEDES						
		OE	906 130 4215	906 130 5115					
Bore	Drive	Cooling	Weight	Mount	Lube	Water Port	Air Inlet	Air Delivery	
85 mm	Through	Water	13 Kg	Flange	Engine Oil	M14	Manifold	M26	
Repair Kits	Full Kit	Head Kit	Gasket Kit	Valve Kit	Valve Plate	Cooling Plate			
	A67RK060	A67RK060A	A67RK060B	A67RK060C	A67RK060V				
Piston	Std	0.25 mm	0.50 mm	0.75 mm	1.00 mm				
	020023	020179	020024	020189	020025				
Rings	A69RK028	A69RK069	A69RK054	A69RK070	A69RK055				
Head	220158	220149 (Comp)			Rear end Cover	220093	Conn Rod	220150	
Crankshaft	220377(L/H)	140203 (Nut)			Front end Cover				
Bolts	140131 (4)	140139 (1)	140138 (4)	140124 (4)					
Other Parts	Front Bush	Liner Sleeve	Base Plate	O Ring	Drive Gear				
	050212	020984	220058	RM1180-30V	220178				

* Now 411 154 004 0

		MAJORSELL PARTS FOR: 411 553 000 0				MAJORSELL REBUILD: 67A134R			
		Users	MERCEDES						
		OE	9061301015						
Bore	Drive	Cooling	Weight	Mount	Lube	Water Port	Air Inlet	Air Delivery	
85 mm	Through	Water	19 Kg	Flange	Engine Oil	14MM	Flange	26MM	
Repair Kits	Full Kit	Head Kit	Gasket Kit	Valve Kit	Cooling Plate	Valve Plate	Valve Plate		
	A67RK072	A67RK072A	A67RK072B	A67RK072C	A67RK065CP	A67RK072V	A67RK065V		
Piston	Std	0.25 mm	0.50 mm	0.75 mm	1.00 mm				
	020023	020179	020024	020189	020025				
Rings	A69RK028	A69RK069	A69RK054	A69RK070	A69RK055				
Head	220160	220357 (Comp)			Rear end Cover	220093	Conn Rod	220100 (2)	
Crankshaft	220472(L/H)	140016 (Nut)			Front end Cover				
Bolts	140102 (4)	140131 (2)	140139 (2)	140138 (6)					
Other Parts	Front Bush	Drive Gear	Liner Sleeve	Base Plate					
	050212	220178	020985 (2)	220058 (2)					

* A67RK072V - Old Style

* A67RK065V - New Style

		MAJORSELL PARTS FOR: 411 553 001 0				MAJORSELL REBUILD: 67A112R			
		Users	MERCEDES						
		OE	9061301515	9061304715					
Bore	Drive	Cooling	Weight	Mount	Lube	Water Port	Air Inlet	Air Delivery	
85 mm	Through	Water	18.5 Kg	Flange	Engine Oil	M14	Flange	M26	
Repair Kits	Full Kit	Head Kit	Gasket Kit	Valve Kit	Valve Plate	Cooling Plate			
	A67RK065	A67RK065A	A67RK065B	A67RK065C	A67RK065V	A67RK065CP			
Piston	Std	0.25 mm	0.50 mm	0.75 mm	1.00 mm				
	020023	020179	020024	020189	020025				
Rings	A69RK028	A69RK069	A69RK054	A69RK070	A69RK055				
Head	220528	220376 (Comp)			Rear end Cover	220093	Conn Rod	220100 (2)	
Crankshaft	220472	140016 (Nut)			Front end Cover				
Bolts	140102 (4)	140131 (2)	140139 (2)	140138 (6)	140124 (4)	140138 (4)			
Other Parts	Front Bush	Drive Gear	O Ring	Base Plate					
	050212	220178	RM1180-30V	220058 (2)					

* Now 411 553 003 0

WABCO SERIES

		MAJORSELL PARTS FOR: 411 553 003 0				MAJORSELL REBUILD: 67A135R		
		Users	MERCEDES					
		OE	9061304715					
Bore	Drive	Cooling	Weight	Mount	Lube	Water Port	Air Inlet	Air Delivery
85 mm	Through	Water	19 Kg	Flange	Engine Oil	M14	Manifold	M26
Repair Kits	Full Kit	Head Kit	Gasket Kit	Valve Kit	Valve Plate	Cooling Plate		
	A67RK065	A67RK065A	A67RK065B	A67RK065C	A67RK065V	A67RK065CP		
Piston	Std	0.25 mm	0.50 mm	0.75 mm	1.00 mm			
	020023	020179	020024	020189	020025			
Rings	A69RK028	A69RK069	A69RK054	A69RK070	A69RK055			
Head	220528	220376 (Comp)			Rear end Cover	220093	Conn Rod	220100 (2)
Crankshaft	220472(L/H)	140203 (Nut)			Front end Cover			
Bolts	140102 (4)	140131 (2)	140139 (2)	140138 (6)	140124 (4)	140138 (4)		
Other Parts	Drive Gear	Base Plate	O Ring					
	220178	220058 (2)	RM1180-30V					

WABCO SERIES

		MAJORSELL PARTS FOR: 412 352 002 0				MAJORSELL REBUILD: 67A056R		
		Users	MERCEDES	EVOBUS				
		OE	9061301415	9061303015				
Bore	Drive	Cooling	Weight	Mount	Lube	Water Port	Air Inlet	Air Delivery
85 mm	Through	Water	13 kg	Flange	Engine Oil	M14	Flange	M26
Repair Kits	Full Kit	Head Kit	Gasket Kit	Valve Kit	Valve Plate	Cooling Plate		
	A67RK066	A67RK066A	A67RK066B	A67RK066C	A67RK066V			
Piston	Std	0.25 mm	0.50 mm	0.75 mm	1.00 mm			
	020023	020179	020024	020189	020025			
Rings	A69RK028	A69RK069	A69RK054	A69RK070	A69RK055			
Head	220278	220277 (Comp)			Rear end Cover	220093	Conn Rod	220150
Crankshaft	220377(L/H)	140203 (Nut)			Front end Cover			
Bolts	140132 (4)	140139 (1)	140151 (2)	140199 (3)	140124 (4)	140138 (4)		
Other Parts	Front Bush	Drive Gear	Base Plate	O Ring	Liner Sleeve			
	050212	220178	220058 (2)	RM1180-30V	020984			

		MAJORSELL PARTS FOR: 412 352 003 0				MAJORSELL REBUILD: 67A033R		
		Users	MAN					
		OE	51541007005					
Bore	Drive	Cooling	Weight	Mount	Lube	Water Port	Air Inlet	Air Delivery
85 mm	Through	Water	12 kg	Flange	Engine Oil	M14	M26	M26
Repair Kits	Full Kit	Head Kit	Gasket Kit	Valve Kit	Valve Plate	Cooling Plate		
	A67RK063	A67RK063A	A67RK063B	A67RK063C	A67RK063V			
Piston	Std	0.25 mm	0.50 mm	0.75 mm	1.00 mm			
	020023	020179	020024	020189	020025			
Rings	A69RK028	A69RK069	A69RK054	A69RK070	A69RK055			
Head	220287	220286 (Comp)			Rear end Cover		Conn Rod	220150
Crankshaft	220488	140016 (Nut)			Front end Cover			
Bolts	140128 (4)	140385 (6)	140199 (6)	140316 (6)	140215 (2)			
Other Parts	Front Flange Bush	Rear Bush	Base Plate	O Ring	O Ring	O Ring	O Ring	Liner Sleeve
	220489	050197	220058	RM0100-30S	RM0845-30V	RM0840-30V	020984	

		MAJORSELL PARTS FOR: 412 352 004 0				MAJORSELL REBUILD: 67A116R		
		Users	VOLVO					
		OE	20382346					
Bore	Drive	Cooling	Weight	Mount	Lube	Water Port	Air Inlet	Air Delivery
85 mm	Non-Through	Water	15 kg	Flange	Engine Oil	M16	Manifold	M26
Repair Kits	Full Kit	Head Kit	Gasket Kit	Valve Kit	Ess Kit	Valve Plate	Cooling Plate	
	A67RK092	A67RK092A	A67RK092B	A67RK067C	A67RK062D	A67RK092V	A67RK092CP	
Piston	Std	0.25 mm	0.50 mm	0.75 mm	1.00 mm			
	020023	020179	020024	020189	020025			
Rings	A69RK028	A69RK069	A69RK054	A69RK070	A69RK055			
Head	220276	220275 (Comp)			Rear end Cover	220571	Conn Rod	220224
Crankshaft	220994	140016 (Nut)			Front end Cover			
Bolts	140128 (4)	140144 (4)	140138 (8)	140124 (4)	140138 (4)			
Other Parts	Front Bush	Base Plate	Liner Sleeve	O Ring	O Ring	Liner Sleeve		
	050195	220058	020984	RM1550-30V	160126	020984		

WABCO SERIES

		MAJORSELL PARTS FOR: 412 352 005 0				MAJORSELL REBUILD: 67A028R		
		Users	VOLVO					
		OE	20382348					
Bore	Drive	Cooling	Weight	Mount	Lube	Water Port	Air Inlet	Air Delivery
85 mm	Non-Through	Water	14 kg	Flange	Engine Oil	M16	Flange	M26
Repair Kits	Full Kit	Head Kit	Gasket Kit	Valve Kit	Ess Kit	Cooling Plate	Valve Plate	
	A67RK067	A67RK067A	A67RK067B	A67RK067C	A67RK062D	A67RK067CP	A67RK067V	
Piston	Std	0.25 mm	0.50 mm	0.75 mm	1.00 mm			
	020023	020179	020024	020189	020025			
Rings	A69RK028	A69RK069	A69RK054	A69RK070	A69RK055			
Head	220274	220226 (Comp)			Rear end Cover	220571	Conn Rod	220224
Crankshaft	220168	140016 (Nut)			Front end Cover			
Bolts	140143 (4)	140144 (4)	140138 (3)	140124 (4)	140138 (4)			
Other Parts	Front Bush	O Ring	Base Plate	O Ring	O Ring			
	050195	160116	220058	RM1250-30V	160126			

		MAJORSELL PARTS FOR: 412 352 008 0				MAJORSELL REBUILD: 67A070R		
		Users	IVECO					
		OE	41211219	41211220				
Bore	Drive	Cooling	Weight	Mount	Lube	Water Port	Air Inlet	Air Delivery
85 mm	Through	Water	13 kg	Flange	Engine Oil	M18	M26	M26
Repair Kits	Full Kit	Head Kit	Gasket Kit	Valve Kit	Ess Kit	Valve Plate		
	A67RK117	A67RK117A	A67RK117B	A67RK117C	A67RK062D	A67RK117V		
Piston	Std	0.25 mm	0.50 mm	0.75 mm	1.00 mm			
	020023	020179	020024	020189	020025			
Rings	A69RK028	A69RK069	A69RK054	A69RK070	A69RK055			
Head	220408	220407 (Comp)			Rear end Cover		Conn Rod	220150
Crankshaft	220623	140015 (R/H)	140321 (L/H)		Front end Cover			
Bolts	140143 (4)	140385 (6)	140199 (6)	140215 (2)				
Other Parts	Rear Bush	Base Plate	O Ring	O Ring				
	050195	220058	RM1250-30V	RM0096-24V				

		MAJORSELL PARTS FOR: 412 352 010 0				MAJORSELL REBUILD: 67A007R		
		Users	MERCEDES					
		OE	4571301715					
Bore	Drive	Cooling	Weight	Mount	Lube	Water Port	Air Inlet	Air Delivery
85 mm	Through	Water	15 kg	Flange	Engine Oil	M18	M26	M26
Repair Kits	Full Kit	Head Kit	Gasket Kit	Valve Kit	Ess Kit	Cooling Plate	Valve Plate	
	A67RK062	A67RK062A	A67RK062B	A67RK062C	A67RK062D	A67RK062CP	A67RK062V	
Piston	Std	0.25 mm	0.50 mm	0.75 mm	1.00 mm			
	020023	020179	020024	020189	020025			
Rings	A69RK028	A69RK069	A69RK054	A69RK070	A69RK055			
Head	220167	220169 (Comp)			Rear end Cover	220093	Conn Rod	220150
Crankshaft	220170	140016 (Nut)			Front end Cover			
Bolts	140144 (4)	140128 (8)	140124 (4)	140138 (4)				
Other Parts	Front Bush	Flange Seal	Liner Sleeve	O Ring (2)	Base Plate			
	050213	160116	020984	RM0840-30V	220058			

WABCO SERIES

		MAJORSELL PARTS FOR: 412 352 011 0				MAJORSELL REBUILD: 67A034R		
		Users	MERCEDES					
		OE	4571301615	9061301615				
Bore	Drive	Cooling	Weight	Mount	Lube	Water Port	Air Inlet	Air Delivery
85 mm	Through	Water	13 kg	Flange	Engine Oil	M16	M30	M26
Repair Kits	Full Kit	Head Kit	Gasket Kit	Valve Kit	Ess Kit	Cooling Plate	Valve Plate	
	A67RK062	A67RK062A	A67RK062B	A67RK062C	A67RK062D	A67RK062CP	A67RK062V	
Piston	Std	0.25 mm	0.50 mm	0.75 mm	1.00 mm			
	020023	020179	020024	020189	020025			
Rings	A69RK028	A69RK069	A69RK054	A69RK070	A69RK055			
Head	220167	220169 (Comp)			Rear end Cover	220093	Conn Rod	220150
Crankshaft	220170	140016 (Nut)			Front end Cover			
Bolts	140144 (4)	140128 (8)	140124 (4)	140138 (4)				
Other Parts	Front Bush	O Ring	Base Plate	O Ring (2)	Liner Sleeve			
	050213	160116	220058	RM0840-30V	020984			

		MAJORSELL PARTS FOR: 412 352 014 0				MAJORSELL REBUILD: 67A171R		
		Users	MERCEDES					
		OE	4571302415					
Bore	Drive	Cooling	Weight	Mount	Lube	Water Port	Air Inlet	Air Delivery
85 mm	Through	Water	14.5 kg	Flange	Engine Oil	M16	M30	M26
Repair Kits	Full Kit	Head Kit	Gasket Kit	Valve Kit	Ess Kit	Cooling Plate	Valve Plate	
	A67RK062	A67RK062A	A67RK062B	A67RK062C	A67RK062D	A67RK062CP	A67RK062V	
Piston	Std	0.25 mm	0.50 mm	0.75 mm	1.00 mm			
	020023	020179	020024	020189	020025			
Rings	A69RK028	A69RK069	A69RK054	A69RK070	A69RK055			
Head	220167	220169 (Comp)			Rear end Cover	220093	Conn Rod	220150
Crankshaft	220473 (L/H)	140203 (Nut)			Front end Cover			
Bolts	140144 (4)	140143 (8)	140124 (4)	140138 (4)				
Other Parts	Front Bush	Liner Sleeve	Base Plate	O Ring		Drive Gear	Gasket	
	050213	020984	220058	RM0840-30V (2)		220180	010421	

		MAJORSELL PARTS FOR: 412 352 016 0				MAJORSELL REBUILD: 67A075R		
		Users	MERCEDES					
		OE	4571302165					
Bore	Drive	Cooling	Weight	Mount	Lube	Water Port	Air Inlet	Air Delivery
85 mm	Through	Water	13 kg	Flange	Engine Oil	M16	M30	M26
Repair Kits	Full Kit	Head Kit	Gasket Kit	Valve Kit	Ess Kit	Cooling Plate	Valve Plate	
	A67RK062	A67RK062A	A67RK062B	A67RK062C	A67RK062D	A67RK062CP	A67RK062V	
Piston	Std	0.25 mm	0.50 mm	0.75 mm	1.00 mm			
	020023	020179	020024	020189	020025			
Rings	A69RK028	A69RK069	A69RK054	A69RK070	A69RK055			
Head	220167	220169 (Comp)			Rear end Cover	220093	Conn Rod	220150
Crankshaft	220473 (L/H)	140203 (Nut)			Front end Cover			
Bolts	140144 (4)	140128(4)	140138 (4)	140124 (4)	140138 (4)			
Other Parts	Base Plate	O Ring	Gasket	O Ring	Front Bush	Liner Sleeve		
	220058	RM0840-30V	010421	160116	050213	020984		

WABCO SERIES

		MAJORSELL PARTS FOR: 412 352 020 0				MAJORSELL REBUILD: 67A181R			
		Users	IVECO						
		OE	504308489						
Bore	Drive	Cooling	Weight	Mount	Lube	Water Port	Air Inlet	Air Delivery	
85 mm	Through	Water	13.5 kg	Flange	Engine Oil	M18	M26	M26	
Repair Kits	Full Kit	Head Kit	Gasket Kit	Valve Kit	Ess Kit	Valve Plate			
	A67RK117	A67RK117A	A67RK117B	A67RK117C	A67RK062D	A67RK117V			
Piston	Std	0.25 mm	0.50 mm	0.75 mm	1.00 mm				
	020023	020179	020024	020189	020025				
Rings	A69RK028	A69RK069	A69RK054	A69RK070	A69RK055				
Head	220408	220407 (Comp)			Rear end Cover		Conn Rod	220150	
Crankshaft	220623	140321 (Nut)			Front end Cover				
Bolts	140143 (4)	140385 (6)	140316 (10)	140199 (4)					
Other Parts	Front Bearing	Rear Bush	Base Plate	Cover Plate	O Ring	O Ring			
	220624	050195	220058	220622	RM1250-30V	RM0096-24V			

		MAJORSELL PARTS FOR: 412 352 025 0				MAJORSELL REBUILD: 67A115R			
		Users	MERCEDES						
		OE	9061301415	9061303015					
Bore	Drive	Cooling	Weight	Mount	Lube	Water Port	Air Inlet	Air Delivery	
85 mm	Through	Water	13 kg	Flange	Engine Oil	M14	Flange	M26	
Repair Kits	Full Kit	Head Kit	Gasket Kit	Valve Kit	Valve Plate	Cooling Plate			
	A67RK066	A67RK066A	A67RK066B	A67RK066C	A67RK066V				
Piston	Std	0.25 mm	0.50 mm	0.75 mm	1.00 mm				
	020023	020179	020024	020189	020025				
Rings	A69RK028	A69RK069	A69RK054	A69RK070	A69RK055				
Head	220278	220277 (Comp)			Rear end Cover	220093	Conn Rod	220150	
Crankshaft	220377(L/H)	140203 (Nut)			Front end Cover				
Bolts	140132 (4)	140151 (2)	140139 (1)	140199 (3)	140138 (4)	140124 (4)	140138 (4)		
Other Parts	Front Bush	Liner Sleeve	Base Plate	Drive Gear	O Ring				
	050212	020984	220058	220178	RM1180-30V				

		MAJORSELL PARTS FOR: 412 352 026 0				MAJORSELL REBUILD: 67A125R			
		Users	MERCEDES						
		OE	4571302165	4571302315	4571302415	4571304415			
Bore	Drive	Cooling	Weight	Mount	Lube	Water Port	Air Inlet	Air Delivery	
85 mm	Through	Water	15 kg	Flange	Engine Oil	M16	M30	M26	
Repair Kits	Full Kit	Head Kit	Gasket Kit	Valve Kit	Ess Kit	Cooling Plate	Valve Plate		
	A67RK062	A67RK062A	A67RK062B	A67RK062C	A67RK062D	A67RK062CP	A67RK062V		
Piston	Std	0.25 mm	0.50 mm	0.75 mm	1.00 mm				
	020023	020179	020024	020189	020025				
Rings	A69RK028	A69RK069	A69RK054	A69RK070	A69RK055				
Head	220167	220169 (Comp)			Rear end Cover	220093	Conn Rod	220150	
Crankshaft	220473(L/H)	140203 (Nut)			Front end Cover				
Bolts	140144 (4)	140128 (4)	140138 (8)	140124 (4)					
Other Parts	Front Bush	Base Plate	Liner Sleeve	Front Gasket					
	050280	220058	020984	010421					

WABCO SERIES

		MAJORSELL PARTS FOR: 412 352 027 0				MAJORSELL REBUILD: 67A126R			
		Users	MERCEDES						
		OE	4571304515						
Bore	Drive	Cooling	Weight	Mount	Lube	Water Port	Air Inlet	Air Delivery	
85 mm	Through	Water	15 kg	Flange	Engine Oil	M16	M30	M26	
Repair Kits	Full Kit	Head Kit	Gasket Kit	Valve Kit	Ess Kit	Cooling Plate	Valve Plate		
	A67RK062	A67RK062A	A67RK062B	A67RK062C	A67RK062D	A67RK062CP	A67RK062V		
Piston	Std	0.25 mm	0.50 mm	0.75 mm	1.00 mm				
	020023	020179	020024	020189	020025				
Rings	A69RK028	A69RK069	A69RK054	A69RK070	A69RK055				
Head	220167	220169 (Comp)			Rear end Cover	220093	Conn Rod	220150	
Crankshaft	220473	140203 (Nut)			Front end Cover				
Bolts	140144 (4)	140128 (4)	140138 (8)	140124 (4)	140138 (4)				
Other Parts	Front Bush	Front Gasket	Base Plate	Drive Gear	Liner Sleeve				
	050280	010421	220058	220180	020984				

		MAJORSELL PARTS FOR: 412 352 030 0				MAJORSELL REBUILD: 67A249R			
		Users	VOLVO						
		OE	20382348						
Bore	Drive	Cooling	Weight	Mount	Lube	Water Port	Air Inlet	Air Delivery	
85 mm	Non-Through	Water	14 kg	Flange	Engine Oil	M16	Flange	M26	
Repair Kits	Full Kit	Head Kit	Gasket Kit	Valve Kit	Ess Kit	Valve Plate	Cooling Plate		
	A67RK067	A67RK067A	A67RK067B	A67RK067C	A67RK062D	A67RK067V	A67RK067CP		
Piston	Std	0.25 mm	0.50 mm	0.75 mm	1.00 mm				
	020023	020179	020024	020189	020025				
Rings	A69RK028	A69RK069	A69RK054	A69RK070	A69RK055				
Head	220274	220226 (Comp)			Rear end Cover	220571	Conn Rod	220224	
Crankshaft	220168	140016 (Nut)			Front end Cover				
Bolts	140143 (4)	140144 (4)	140124 (4)	140138 (8)	140138 (4)				
Other Parts	Front Bush	Base Plate	O ring	O Ring	O Ring				
	050195	220058	010262	RM1250-30V	160126				

		MAJORSELL PARTS FOR: 412 442 000 0				MAJORSELL REBUILD: 67A030R			
		Users	DAF	RVI					
		OE	1522159	5010550086	5600621115				
Bore	Drive	Cooling	Weight	Mount	Lube	Water Port	Air Inlet	Air Delivery	
75 mm	Non-Through	Water	17 kg	Flange	Engine Oil	M14	M26	M26	
Repair Kits	Full Kit	Head Kit	Gasket Kit	Valve Kit	Ess Kit	Valve Plate	Cooling Plate		
	A67RK074	A67RK074A	A67RK074B	A67RK074C	A67RK082D	A67RK074V	A67RK074CP		
Piston	Std	0.25 mm	0.50 mm	0.75 mm	1.00 mm				
	020067	020176	020076	020196	020095				
Rings	A67RK013	A67RK101	A67RK014	A67RK102	A67RK023				
Head	220342	220242 (Comp)			Rear end Cover		Conn Rod	220315 (2)	
Crankshaft		140016 (Nut)			Front end Cover				
Bolts	140149 (6)	140151 (2)	140138 (6)	140199 (2)	140316 (4)	140199 (4)			
Other Parts	Front Bush	Rear Bush	Base Plate	O Ring	O Ring	Liner Sleeve			
	220445	050216	220058 (2)	BS250S	160114	020987			

WABCO SERIES

		MAJORSELL PARTS FOR: 412 442 001 0				MAJORSELL REBUILD: 67A083R		
		Users	RVI					
		OE	5010437567					
Bore	Drive	Cooling	Weight	Mount	Lube	Water Port	Air Inlet	Air Delivery
75 mm	Non-Through	Water	20 kg	Flange	Engine Oil	M14	M26	M26
Repair Kits	Full Kit	Head Kit	Gasket Kit	Valve Kit	Ess Kit	Valve Plate	Cooling Plate	
	A67RK074	A67RK074A	A67RK074B	A67RK074C	A67RK082D	A67RK074V	A67RK074CP	
Piston	Std	0.25 mm	0.50 mm	0.75 mm	1.00 mm			
	020067	020176	020076	020196	020095			
Rings	A67RK013	A67RK101	A67RK014	A67RK102	A67RK023			
Head	220342	220242 (Comp)			Rear end Cover		Conn Rod	220315 (2)
Crankshaft	220444	140016 (Nut)			Front end Cover			
Bolts	140149 (6)	140151 (2)	140138 (6)					
Other Parts	Front Bush	Rear Bush	Base Plate	Liner Sleeve				
	220443	050216	220058	020987				

		MAJORSELL PARTS FOR: 412 636 000 0				MAJORSELL REBUILD: 67A061R		
		Users	EVOBUS	MERCEDES				
		OE	9061303215	9061300915	9061302215			
Bore	Drive	Cooling	Weight	Mount	Lube	Water Port	Air Inlet	Air Delivery
85 mm	Through	Water	19 kg	Flange	Engine Oil	M14	Manifold	M26
Repair Kits	Full Kit	Head Kit	Gasket Kit	Valve Kit	Ess Kit	Valve Plate	Cooling Plate	
	A67RK069	A67RK069A	A67RK069B	A67RK069C	A67RK073D	A67RK069V	A67RK069CP	
Piston	Std	0.25 mm	0.50 mm	0.75 mm	1.00 mm			
	020023	020179	020024	020189	020025			
Rings	A69RK028	A69RK069	A69RK054	A69RK070	A69RK055			
Head	220160	220479 (Comp)			Rear end Cover	220093	Conn Rod	220100 (2)
Crankshaft	220775(L/H)	140203 (Nut)			Front end Cover			
Bolts	140131 (6)	140139 (2)	140138 (6)	140124 (4)	140138 (4)	140199 (2)		
Other Parts	Front Bush	Liner Sleeve	Base Plate	O Ring	Drive Gear			
	050212	020985 (2)	220058 (2)	RM1180-30V	220178			

		MAJORSELL PARTS FOR: 412 636 001 0				MAJORSELL REBUILD: 67A076R		
		Users	DAF	MERCEDES				
		OE	9061301615	9061302115	1518595			
Bore	Drive	Cooling	Weight	Mount	Lube	Water Port	Air Inlet	Air Delivery
85 mm	Through	Water	19 kg	Flange	Engine Oil	M14	Manifold	M26
Repair Kits	Full Kit	Head Kit	Gasket Kit	Valve Kit	Ess Kit	Valve Plate	Cooling Plate	
	A67RK065	A67RK065A	A67RK065B	A67RK065C	A67RK065D	A67RK065V1	A67RK065CP	
Piston	Std	0.25 mm	0.50 mm	0.75 mm	1.00 mm			
	020023	020179	020024	020189	020025			
Rings	A69RK028	A69RK069	A69RK054	A69RK070	A69RK055			
Head	220280	220279 (Comp)			Rear end Cover	220093	Conn Rod	220100 (2)
Crankshaft		140016 (Nut)			Front end Cover			
Bolts	140143 (4)	140139 (2)	140138 (6)	140124 (4)	140138 (4)	140199 (2)		
Other Parts	Front Bush	Liner Sleeve	Base Plate	O Ring	O Ring			
	050212	020985 (2)	220058 (2)	RM1180-30V	RM0880-30V			

WABCO SERIES

 NO IMAGE AVAILABLE		MAJORSELL PARTS FOR: 412 636 003 0				MAJORSELL REBUILD: 67A081R			
		Users	MERCEDES						
		OE	9061304515						
Bore	Drive	Cooling	Weight	Mount	Lube	Water Port	Air Inlet	Air Delivery	
85 mm	Through	Water	20 kg	Flange	Engine Oil	M14	Flange	M26	
Repair Kits	Full Kit	Head Kit	Gasket Kit	Valve Kit	Valve Plate	Cooling Plate			
	A67RK069	A67RK069A	A67RK069B	A67RK069C	A67RK073D	A67RK069V	A67RK069CP		
Piston	Std	0.25 mm	0.50 mm	0.75 mm	1.00 mm				
	020023	020179	020024	020189	020025				
Rings	A69RK028	A69RK069	A69RK054	A69RK070	A69RK055				
Head	220160	220479 (Comp)			Rear end Cover	220093	Conn Rod	220100 (2)	
Crankshaft	220775	140203 (Nut)			Front end Cover				
Bolts	140131 (6)	140199 (2)	140138 (6)	140124 (4)	140138 (4)	140139 (2)			
Other Parts	Front Bush	Liner Sleeve	O Ring	Base Plate	Drive Gear				
	050212	020985 (2)	RM1180-30V	220058 (2)	220178				

		MAJORSELL PARTS FOR: 412 704 000 0				MAJORSELL REBUILD: 67A026R			
		Users	VOLVO						
		OE	20382345	20478151					
Bore	Drive	Cooling	Weight	Mount	Lube	Water Port	Air Inlet	Air Delivery	
85 mm	Non-Through	Water	20 kg	Flange	Engine Oil	M16	Manifold	M26	
Repair Kits	Full Kit	Head Kit	Gasket Kit	Valve Kit	Ess Kit	Valve Plate	Cooling Plate		
	A67RK084	A67RK084A	A67RK084B	A67RK065C	A67RK073D	A67RK084V	A67RK084CP		
Piston	Std	0.25 mm	0.50 mm	0.75 mm	1.00 mm				
	020023	020179	020024	020189	020025				
Rings	A69RK028	A69RK069	A69RK054	A69RK070	A69RK055				
Head	220296	220295 (Comp)			Rear end Cover	220227	Conn Rod	220224 (2)	
Crankshaft	220572	140016 (Nut)			Front end Cover				
Bolts	140143 (6)	140210 (2)	140138 (6)	140199 (2)	140124 (4)	140138 (4)			
Other Parts	Front Bush	O Ring	Base Plate	Liner Sleeve					
	050190	RM1550-30V	220058 (2)	020986					

		MAJORSELL PARTS FOR: 412 704 001 0				MAJORSELL REBUILD: 67A027R			
		Users	SCANIA	RVI	VOLVO				
		OE	1505917						
Bore	Drive	Cooling	Weight	Mount	Lube	Water Port	Air Inlet	Air Delivery	
85 mm	Non-Through	Water	18 kg	Flange	Engine Oil	M16	Manifold	M26	
Repair Kits	Full Kit	Head Kit	Gasket Kit	Valve Kit	Ess Kit	Valve Plate	Cooling Plate		
	A67RK068	A67RK068A	A67RK068B	A67RK068C	A67RK073D	A67RK068V	A67RK068CP		
Piston	Std	0.25 mm	0.50 mm	0.75 mm	1.00 mm				
	020023	020179	020024	020189	020025				
Rings	A69RK028	A69RK069	A69RK054	A69RK070	A69RK055				
Head	220245	220166 (Comp)			Rear end Cover	220227	Conn Rod	220224 (2)	
Crankshaft	220229	140016 (Nut)			Front end Cover				
Bolts	140143 (6)	140275 (2)	140138 (6)	140176 (2)	140124 (4)	140138 (4)			
Other Parts	Front Bush	O Ring	Base Plate	Liner Sleeve					
	050190	RM1250-30V	220058 (2)	020987					

* Now 412 704 008 0

WABCO SERIES

		MAJORSELL PARTS FOR: 412 704 004 0				MAJORSELL REBUILD: 67A047R		
		Users	VOLVO					
		OE	85000329					
Bore	Drive	Cooling	Weight	Mount	Lube	Water Port	Air Inlet	Air Delivery
85 mm	Non-Through	Water	20 kg	Flange	Engine Oil	M16	Manifold	M26
Repair Kits	Full Kit	Head Kit	Gasket Kit	Valve Kit	Ess Kit	Valve Plate	Cooling Plate	
	A67RK068	A67RK068A	A67RK068B	A67RK065C	A67RK073D	A67RK068V	A67RK068CP	
Piston	Std	0.25 mm	0.50 mm	0.75 mm	1.00 mm			
	020023	020179	020024	020189	020025			
Rings	A69RK028	A69RK069	A69RK054	A69RK070	A69RK055			
Head	220245	220166 (Comp)			Rear end Cover	220227	Conn Rod	220224 (2)
Crankshaft	220229	140016 (Nut)			Front end Cover			
Bolts	140143 (6)	140275 (2)	140138 (6)	140276 (2)	140124 (4)	140138 (4)		
Other Parts	Front Bush	Base Plate	O Ring	O Ring	Liner Sleeve			
	050190	220058 (2)	RM1250-30V	160126	020986			

* Now 412 704 008 0

		MAJORSELL PARTS FOR: 412 704 005 0				MAJORSELL REBUILD: 67A046R		
		Users	VOLVO					
		OE	20701801					
Bore	Drive	Cooling	Weight	Mount	Lube	Water Port	Air Inlet	Air Delivery
85 mm	Non-Through	Water		Flange	Engine Oil			
Repair Kits	Full Kit	Head Kit	Gasket Kit	Valve Kit	Ess Kit	Valve Plate	Cooling Plate	
	A67RK068	A67RK068A	A67RK068B	A67RK065C	A67RK073D	A67RK068V	A67RK068CP	
Piston	Std	0.25 mm	0.50 mm	0.75 mm	1.00 mm			
	020023	020179	020024	020189	020025			
Rings	A69RK028	A69RK069	A69RK054	A69RK070	A69RK055			
Head	220245	220166 (Comp)			Rear end Cover	220227	Conn Rod	220224 (2)
Crankshaft	220229	140016 (Nut)			Front end Cover			
Bolts	140143 (6)	140139 (2)	140138 (6)	140199 (2)	140124 (4)	140138 (4)		
Other Parts	Front Bush	O Ring	Base Plate	Liner Sleeve				
	050190	RM1250-30V	220058 (2)	020986 (2)				

* Replaced by 412 704 008 0

		MAJORSELL PARTS FOR: 412 704 006 0				MAJORSELL REBUILD: 67A071R		
		Users						
		OE						
Bore	Drive	Cooling	Weight	Mount	Lube	Water Port	Air Inlet	Air Delivery
85mm	Non-Through	Water		Flange	Engine			
Repair Kits	Full Kit	Head Kit	Gasket Kit	Valve Kit	Ess Kit	Valve Plate	Cooling Plate	
	A67RK084	A67RK084A	A67RK084B	A67RK084C	A67RK073D	A67RK084V	A67RK084CP	
Piston	Std	0.25 mm	0.50 mm	0.75 mm	1.00 mm			
	020023	020179	020024	020189	020025			
Rings	A69RK028	A69RK069	A69RK054	A69RK070	A69RK055			
Head	220296	220295 (Comp)			Rear end Cover	220227	Conn Rod	220224 (2)
Crankshaft	220572	140016 (Nut)			Front end Cover			
Bolts	140143 (6)	140275 (2)	140276 (2)	140124 (4)	140138 (4)			
Other Parts	Front Bush	Sump Cover	Seal	Flange Seal				
	050190	220058 (2)	RM0880-30V	RM1550-30V				

WABCO SERIES

		MAJORSELL PARTS FOR: 412 704 008 0				MAJORSELL REBUILD: 67A041R		
		Users	VOLVO	RVI	DAF			
		OE	20701801 1505917	20382347 1516708	20547525	20569224	5021209007	7420569224
Bore	Drive	Cooling	Weight	Mount	Lube	Water Port	Air Inlet	Air Delivery
85 mm	Non-Through	Water	20 kg	Flange	Engine Oil	M16	Manifold	M26
Repair Kits	Full Kit	Head Kit	Gasket Kit	Valve Kit	Ess Kit	Valve Plate	Cooling Plate	
	A67RK068	A67RK068A	A67RK068B	A67RK065C	A67RK073D	A67RK068V1	A67RK068CP	
Piston	Std	0.25 mm	0.50 mm	0.75 mm	1.00 mm			
	020023	020179	020024	020189	020025			
Rings	A69RK028	A69RK069	A69RK054	A69RK070	A69RK055			
Head	220577	220576 (Comp)			Rear end Cover	220227	Conn Rod	220224 (2)
Crankshaft	220229	140016 (Nut)			Front end Cover			
Bolts	140143 (6)	140275 (2)	140138 (6)	140276 (2)	140124 (4)	140138 (4)		
Other Parts	Front Bush	Base Plate	O Ring	O Ring	Liner Sleeve			
	050190	220058 (2)	RM1250-30V	160126	020986			

		MAJORSELL PARTS FOR: 412 704 009 0				MAJORSELL REBUILD: 67A103R		
		Users	VOLVO	RVI	SCANIA			
		OE	20713886					
Bore	Drive	Cooling	Weight	Mount	Lube	Water Port	Air Inlet	Air Delivery
85 mm	Non-Through	Water	20 kg	Flange	Engine Oil	M16	Manifold	M26
Repair Kits	Full Kit	Head Kit	Gasket Kit	Valve Kit	Ess Kit	Valve Plate	Cooling Plate	
	A67RK068	A67RK068A	A67RK068B	A67RK065C	A67RK073D	A67RK068V1	A67RK068CP	
Piston	Std	0.25 mm	0.50 mm	0.75 mm	1.00 mm			
	020023	020179	020024	020189	020025			
Rings	A69RK028	A69RK069	A69RK054	A69RK070	A69RK055			
Head	220577	220576 (Comp)			Rear end Cover	220227	Conn Rod	220224 (2)
Crankshaft	220229	140016 (Nut)			Front end Cover			
Bolts	140143 (6)	140275 (2)	140138 (6)	140276 (2)	140124 (4)	140138 (4)		
Other Parts	Front Bush	Base Plate	O Ring	Liner Sleeve				
	050190	220058 (2)	RM1250-30V	020986				

		MAJORSELL PARTS FOR: 412 704 013 0				MAJORSELL REBUILD: 67A078R		
		Users	RVI	VOLVO				
		OE	20574763	20775224	20866605			
Bore	Drive	Cooling	Weight	Mount	Lube	Water Port	Air Inlet	Air Delivery
85 mm	Non-Through	Water	19 kg	Flange	Engine Oil	M16	Manifold	M26
Repair Kits	Full Kit	Head Kit	Gasket Kit	Valve Kit	Ess Kit	Valve Plate	Cooling Plate	
	A67RK084	A67RK084A	A67RK084B	A67RK065C	A67RK073D	A67RK084V1	A67RK084CP	
Piston	Std	0.25 mm	0.50 mm	0.75 mm	1.00 mm			
	020023	020179	020024	020189	020025			
Rings	A69RK028	A69RK069	A69RK054	A69RK070	A69RK055			
Head	220953	220295 (Comp)			Rear end Cover	220227	Conn Rod	220224 (2)
Crankshaft	220572	140016 (Nut)			Front end Cover			
Bolts	140143 (6)	140124 (4)	140138 (6)	140138 (4)				
Other Parts	Front Bush	O Ring	Base Plate	O Ring				
	050190	RM1350-30V	220058 (2)	160126				

WABCO SERIES

		MAJORSELL PARTS FOR: 412 704 014 0				MAJORSELL REBUILD: 67A044R		
		Users	VOLVO					
		OE	85000614	20569928				
Bore	Drive	Cooling	Weight	Mount	Lube	Water Port	Air Inlet	Air Delivery
85 mm	Non-Through	Water	20 kg	Flange	Engine Oil	M16	Manifold	M26
Repair Kits	Full Kit	Head Kit	Gasket Kit	Valve Kit	Ess Kit	Valve Plate	Cooling Plate	
	A67RK084	A67RK084A	A67RK084B	A67RK065C	A67RK073D	A67RK084V	A67RK084CP	
Piston	Std	0.25 mm	0.50 mm	0.75 mm	1.00 mm			
	020023	020179	020024	020189	020025			
Rings	A69RK028	A69RK069	A69RK054	A69RK070	A69RK055			
Head	220296	220295 (Comp)			Rear end Cover	220227	Conn Rod	220224 (2)
Crankshaft	220572	140016 (Nut)			Front end Cover			
Bolts	140143 (6)	140275 (2)	140210 (2)	140276 (2)	140124 (4)	140138 (4)		
Other Parts	Front Bush	O Ring	Base Plate	O Ring				
	050190	RM1550-30V	220058 (2)	160126				

		MAJORSELL PARTS FOR: 412 704 015 0				MAJORSELL REBUILD: 67A104R		
		Users	VOLVO					
		OE	20845313					
Bore	Drive	Cooling	Weight	Mount	Lube	Water Port	Air Inlet	Air Delivery
85 mm	Non-Through	Water	20 kg	Flange	Engine Oil	M16	Manifold	M26
Repair Kits	Full Kit	Head Kit	Gasket Kit	Valve Kit	Ess Kit	Valve Plate	Cooling Plate	
	A67RK084	A67RK084A	A67RK084B	A67RK065C	A67RK073D	A67RK084V	A67RK084CP	
Piston	Std	0.25 mm	0.50 mm	0.75 mm	1.00 mm			
	020023	020179	020024	020189	020025			
Rings	A69RK028	A69RK069	A69RK054	A69RK070	A69RK055			
Head	220296	220295 (Comp)			Rear end Cover	220227	Conn Rod	220224 (2)
Crankshaft	220572	140016 (Nut)			Front end Cover			
Bolts	140143 (6)	140275 (2)	140276 (2)	140124 (4)	140138 (4)			
Other Parts	Front Bush	O Ring	Base Plate	O Ring	O Ring			
	050190	RM0880-30V	220058 (2)	RM1650-30V	160126			

		MAJORSELL PARTS FOR: 412 704 016 0				MAJORSELL REBUILD: 67A105R		
		Users	VOLVO					
		OE	20866605					
Bore	Drive	Cooling	Weight	Mount	Lube	Water Port	Air Inlet	Air Delivery
85 mm	Non-Through	Water	19 kg	Flange	Engine Oil	M16	Manifold	M26
Repair Kits	Full Kit	Head Kit	Gasket Kit	Valve Kit	Ess Kit	Valve Plate	Cooling Plate	
	A67RK084	A67RK084A	A67RK084B	A67RK065C	A67RK073D	A67RK084V1	A67RK084CP	
Piston	Std	0.25 mm	0.50 mm	0.75 mm	1.00 mm			
	020023	020179	020024	020189	020025			
Rings	A69RK028	A69RK069	A69RK054	A69RK070	A69RK055			
Head	220953	220296 (Comp)			Rear end Cover	220227	Conn Rod	220224 (2)
Crankshaft	220572	140016 (Nut)			Front end Cover			
Bolts	140143 (6)	140275 (2)	140138 (6)	140276 (2)	140124 (4)	140138 (4)		
Other Parts	Front Bush	Base Plate	O Ring	O Ring				
	050190	220058 (2)	RM1350-30V	160126				

WABCO SERIES

		MAJORSELL PARTS FOR: 412 704 018 0				MAJORSELL REBUILD: 67A117R		
		Users	VOLVO					
		OE	21172036	85003282				
Bore	Drive	Cooling	Weight	Mount	Lube	Water Port	Air Inlet	Air Delivery
85 mm	Non-Through	Water	19 kg	Flange	Engine Oil	M16	Manifold	M26
Repair Kits	Full Kit	Head Kit	Gasket Kit	Valve Kit	Ess Kit	Valve Plate	Cooling Plate	
	A67RK085	A67RK085A	A67RK085B	A67RK085C	A67RK085D	A67RK085V	A67RK085CP	
Piston	Std	0.25 mm	0.50 mm	0.75 mm	1.00 mm			
	020023	020179	020024	020189	020025			
Rings	A69RK028	A69RK069	A69RK054	A69RK070	A69RK055			
Head	220331	220299 (Comp)			Rear end Cover	220187	Conn Rod	220150 (2)
Crankshaft		140016 (Nut)			Front end Cover			
Bolts	140143 (6)	140275 (2)	140138 (6)	140276 (2)				
Other Parts	Front Bush	Rear Bush	Base Plate	O Ring	O Ring			
	220248	050249	220058 (2)	RM1650-30V	160126			

		MAJORSELL PARTS FOR: 412 704 019 0				MAJORSELL REBUILD: 67A137R		
		Users	VOLVO					
		OE						
Bore	Drive	Cooling	Weight	Mount	Lube	Water Port	Air Inlet	Air Delivery
85 mm	Non-Through	Water	19 kg	Flange	Engine Oil	M16	Manifold	M26
Repair Kits	Full Kit	Head Kit	Gasket Kit	Valve Kit	Ess Kit	Valve Plate	Cooling Plate	
	A67RK085	A67RK085A	A67RK085B	A67RK085C	A67RK085D	A67RK085V1	A67RK085CP	
Piston	Std	0.25 mm	0.50 mm	0.75 mm	1.00 mm			
	020023	020179	020024	020189	020025			
Rings	A69RK028	A69RK069	A69RK054	A69RK070	A69RK055			
Head	220331	220570 (Comp)			Rear end Cover	220227	Conn Rod	220224 (2)
Crankshaft	220572	140016 (Nut)			Front end Cover			
Bolts	140143 (6)	140275 (2)	140138 (4)	140276 (2)	140124 (4)			
Other Parts	Front Bush	O Ring	Base Plate	O Ring				
	050190	RM1450-30V	220058 (2)	160126				

WABCO SERIES

		MAJORSELL PARTS FOR: 911 141 001 0				MAJORSELL REBUILD: 67A025R		
		Users	Seddon/Atkinson		Perkins	DAF	IVECO	AWD
		OE	3297422					
Bore	Drive	Cooling	Weight	Mount	Lube	Water Port	Air Inlet	Air Delivery
75 mm	Through	Water	13 kg	Flange	Engine Oil	3/8"	M26	M26
Repair Kits	Full Kit	Head Kit	Gasket Kit	Valve Kit	Valve Plate	Cooling Plate		
	A67RK037	A67RK037A	A67RK037B	A67RK035C	A67RK037V			
Piston	Std	0.25 mm	0.50 mm	0.75 mm	1.00 mm			
	020067	020176	020076	020196	020095			
Rings	A67RK013	A67RK101	A67RK014	A67RK102	A67RK023			
Head					Rear end Cover		Conn Rod	
Crankshaft					Front end Cover			
Bolts	140104 (4)	140138 (4)						
Other Parts	Front and Rear Bush		Inserts	Blanking Plug				
	050200		050159	080004 (2)				

		MAJORSELL PARTS FOR: 911 142 000 0				MAJORSELL REBUILD: 67A065R		
		Users	FODEN	DAF				
		OE						
Bore	Drive	Cooling	Weight	Mount	Lube	Water Port	Air Inlet	Air Delivery
90 mm	Through	Water	13 kg	Base	Engine Oil	3/8"	M26	M26
Repair Kits	Full Kit	Head Kit	Gasket Kit	Valve Kit	Valve Plate	Cooling Plate		
	A67RK036	A67RK036A	A67RK036B	A67RK024C				
Piston	Std	0.25 mm	0.50 mm	0.75 mm	1.00 mm	1.50 mm		
	020068	020197	020069	020198	020070	020071		
Rings	A67RK007	A67RK099	A67RK009	A67RK100	A67RK011			
Head					Rear end Cover		Conn Rod	
Crankshaft		140016 (Nut)			Front end Cover			
Bolts	140104 (4)	140137 (4)						
Other Parts	Front & Rear Bush		Inserts	Blanking Plug	O Ring			
	050200		050159	080004 (2)	RM0950-25			

		MAJORSELL PARTS FOR: 911 145 002 0				MAJORSELL REBUILD: 67A085R		
		Users	DAF					
		OE	1505265					
Bore	Drive	Cooling	Weight	Mount	Lube	Water Port	Air Inlet	Air Delivery
75 mm	Through	Water	12 kg	Base	Engine Oil	3/8"	M26	M26
Repair Kits	Full Kit	Head Kit	Gasket Kit	Valve Kit	Valve Plate	Cooling Plate		
	A67RK037	A67RK037A	A67RK037B	A67RK035C	A67RK055V			
Piston	Std	0.25 mm	0.50 mm	0.75 mm	1.00 mm			
	020067	020176	020076	020196	020095			
Rings	A67RK013	A67RK101	A67RK014	A67RK102	A67RK023			
Head					Rear end Cover		Conn Rod	
Crankshaft					Front end Cover			
Bolts	140104 (4)	140138 (4)						
Other Parts	Front and Rear Bush		Inserts	Blanking Plug				
	050200		050159	080004 (2)				

WABCO SERIES

		MAJORSELL PARTS FOR: 911 145 050 0				MAJORSELL REBUILD: 67A031R		
		Users	IVECO					
		OE	04859191					
Bore	Drive	Cooling	Weight	Mount	Lube	Water Port	Air Inlet	Air Delivery
75 mm	Non-through	Water	10 kg	Flange	Engine Oil	16 mm	26 mm	26 mm
Repair Kits	Full Kit	Head Kit	Gasket Kit	Valve Kit	Valve Plate	Cooling Plate		
	A67RK038	A67RK038A	A67RK038B	A67RK038C	A67RK038V			
Piston	Std	0.25 mm	0.50 mm	0.75 mm	1.00 mm			
	020067	020176	020076	020196	020095			
Rings	A67RK013	A67RK101	A67RK014	A67RK102	A67RK023			
Head					Rear end Cover		Conn Rod	220315
Crankshaft		140015 (Nut)			Front end Cover			
Bolts	140143 (4)	140148 (4)	140127 (4)	140138 (4)				
Other Parts	Front Bush	Rear End Gasket		Flange Gasket		Oil Seal	Base Plate	
	050158	010262		010364		110037	080038 (2)	

		MAJORSELL PARTS FOR: 911 145 060 0				MAJORSELL REBUILD: 67A016R		
		Users	IVECO					
		OE	99436216			500310904		
Bore	Drive	Cooling	Weight	Mount	Lube	Water Port	Air Inlet	Air Delivery
75 mm	Non-Through	Water	10 kg	Flange	Engine Oil	M16	Manifold	M26
Repair Kits	Full Kit	Head Kit	Gasket Kit	Valve Kit	Valve Plate	Cooling Plate		
	A67RK047	A67RK047A	A67RK047B	A67RK047C	A67RK047V			
Piston	Std	0.25 mm	0.50 mm	0.75 mm	1.00 mm			
	020067	020176	020076	020196	020095			
Rings	A67RK013	A67RK101	A67RK014	A67RK102	A67RK023			
Head		220772 (Comp)			Rear end Cover		Conn Rod	220315
Crankshaft		140015 (Nut)			Front end Cover			
Bolts	140128 (4)	140138 (4)	140124 (4)	140138 (4)	140138 (4)			
Other Parts	Front Bush	Flange Gasket	Oil Seal	Base Plate	Speedi Sleeve			
	050158	010364	110037	080038 (2)	050283			

		MAJORSELL PARTS FOR: 911 145 560 0				MAJORSELL REBUILD: 67A066R		
		Users	IVECO					
		OE						
Bore	Drive	Cooling	Weight	Mount	Lube	Water Port	Air Inlet	Air Delivery
75 mm	Non-Through	Water		Flange	Engine Oil			
Repair Kits	Full Kit	Head Kit	Gasket Kit	Valve Kit	Valve Plate	Cooling Plate		
	A67RK047	A67RK047A	A67RK047B	A67RK047C	A67RK047V			
Piston	Std	0.25 mm	0.50 mm	0.75 mm	1.00 mm			
	020067	020176	020076	020196	020095			
Rings	A67RK013	A67RK101	A67RK014	A67RK102	A67RK023			
Head					Rear end Cover		Conn Rod	
Crankshaft		140015 (Nut)			Front end Cover			
Bolts	140140 (4)	140138 (4)	140124 (4)	140138 (4)				
Other Parts	Front Bush	Flange Gasket	Oil Seal	Base Plate				
	050158	010364	110037	080038 (2)				

WABCO SERIES

		MAJORSELL PARTS FOR: 911 146 003 0				MAJORSELL REBUILD: 67A055R		
		Users						
		OE						
Bore	Drive	Cooling	Weight	Mount	Lube	Water Port	Air Inlet	Air Delivery
90 mm	Through	Water	13 kg	Flange	Engine Oil	¾"	M26	M26
Repair Kits	Full Kit	Head Kit	Gasket Kit	Valve Kit	Valve Plate	Cooling Plate		
	A67RK036	A67RK036A	A67RK036B	A67RK024C				
Piston	Std	0.25 mm	0.50 mm	0.75 mm	1.00 mm	1.50 mm		
	020068	020197	020069	020198	020070	020071		
Rings	A67RK007	A67RK099	A67RK009	A67RK100	A67RK011			
Head					Rear end Cover		Conn Rod	
Crankshaft		140277 (Nut)			Front end Cover			
Bolts	140104 (4)	140138 (4)						
Other Parts	Front and Rear Bush		Inserts	O Ring	Blanking Plug			
	050200		050180	RM0950-25	080004 (2)			

		MAJORSELL PARTS FOR: 911 153 003 0				MAJORSELL REBUILD: 67A143R		
		Users	CUMMINS					
		OE						
Bore	Drive	Cooling	Weight	Mount	Lube	Water Port	Air Inlet	Air Delivery
85 mm	Through	Water	17 kg	Flange	Engine Oil	¾"	Manifold	M27
Repair Kits	Full Kit	Head Kit	Gasket Kit	Valve Kit	Valve Plate	Cooling Plate		
	A67RK058	A67RK058A	A67RK058B	A67RK058C	A67RK058V			
Piston	Std	0.25 mm	0.50 mm	0.75 mm	1.00 mm			
	020023	020179	020024	020189	020025			
Rings	A69RK028	A69RK069	A69RK054	A69RK070	A69RK055			
Head	220345	220344 (Comp)			Rear end Cover		Conn Rod	
Crankshaft					Front end Cover			
Bolts	140143 (4)	140151 (5)	140199 (5)	140138 (4)				
Other Parts	Front Bush	Rear Bearing	Base Plate					
	050207	6308	220058					

		MAJORSELL PARTS FOR: 911 153 010 0				MAJORSELL REBUILD: 67A174R		
		Users	CUMMINS					
		OE	3969110					
Bore	Drive	Cooling	Weight	Mount	Lube	Water Port	Air Inlet	Air Delivery
85 mm	Through	Water	18.5 kg	Flange	Engine Oil	¾ UNF	Manifold	M27
Repair Kits	Full Kit	Head Kit	Gasket Kit	Valve Kit	Valve Plate	Cooling Plate		
	A67RK058	A67RK058A	A67RK058B	A67RK058C	A67RK058V			
Piston	Std	0.25 mm	0.50 mm	0.75 mm	1.00 mm			
	020023	020179	020024	020189	020025			
Rings	A69RK028	A69RK069	A69RK054	A69RK070	A69RK055			
Head	220345	220344 (Comp)			Rear end Cover	220666	Conn Rod	220100
Crankshaft					Front end Cover			
Bolts	140128 (4)	140151 (5)	140138 (4)	140199 (5)				
Other Parts	Front Bush	Rear Bearing	Base Plate	O Ring				
	050253	6308	220058	RM1150-30V				

* Replaced by 911 153 938 0

WABCO SERIES

		MAJORSELL PARTS FOR: 911 153 510 0				MAJORSELL REBUILD: 67A024R		
		Users	CUMMINS					
		OE						
Bore	Drive	Cooling	Weight	Mount	Lube	Water Port	Air Inlet	Air Delivery
85 mm	Non-Through	Water		Flange	Engine Oil			
Repair Kits	Full Kit	Head Kit	Gasket Kit	Valve Kit	Ess Kit	Ess Kit	Valve Plate	
	A67RK058	A67RK058A	A67RK058B	A67RK058C	A67RK058D	A67RK058D1	A67RK058V	
Piston	Std	0.25 mm	0.50 mm	0.75 mm	1.00 mm			
	020023	020179	020024	020189	020025			
Rings	A69RK028	A69RK069	A69RK054	A69RK070	A69RK055			
Head	220542	220541 (Comp)			Rear end Cover	220666	Conn Rod	220100
Crankshaft	220722	140332 (Nut)			Front end Cover			
Bolts	140128 (4)	140151 (5)	140138 (4)	140199 (2)				
Other Parts	Base Plate	Front Brush	Rear Bush	Drive Gear				
	220058	050253	6308C3	220721				

		MAJORSELL PARTS FOR: 911 153 520 0				MAJORSELL REBUILD: 67A145R		
		Users	CUMMINS					
		OE	3103403	3558163	4059825	4952750		
Bore	Drive	Cooling	Weight	Mount	Lube	Water Port	Air Inlet	Air Delivery
85 mm	Through	Water	14 kg	Flange	Engine Oil	¾ "	Manifold	M26
Repair Kits	Full Kit	Head Kit	Gasket Kit	Valve Kit	Ess Kit	Valve Plate		
	A67RK058	A67RK058A	A67RK058B	A67RK058C	A67RK058D	A67RK058V		
Piston	Std	0.25 mm	0.50 mm	0.75 mm	1.00 mm			
	020023	020179	020024	020189	020025			
Rings	A69RK028	A69RK069	A69RK054	A69RK070	A69RK055			
Head	220345	220344 (Comp)			Rear end Cover		Conn Rod	220100
Crankshaft					Front end Cover			
Bolts	140128 (4)	140151 (5)	140138 (4)	140210	140083			
Other Parts	Front Bush	Rear Bearing	Base Plate	Front Flange Gasket		Rear Flange Gasket		Pump Adapter
	050216	6308	220058	010097		010438		220719

 NO IMAGE AVAILABLE		MAJORSELL PARTS FOR: 911 153 524 0				MAJORSELL REBUILD: 67A108R		
		Users						
		OE						
Bore	Drive	Cooling	Weight	Mount	Lube	Water Port	Air Inlet	Air Delivery
85 mm		Water		Flange	Engine Oil	3/4" UNF	Flange	M27
Repair Kits	Full Kit	Head Kit	Gasket Kit	Valve Kit	Ess Kit	Valve Plate		
	A67RK058	A67RK058A	A67RK058B	A67RK058C	A67RK062D	A67RK058V		
Piston	Std	0.25 mm	0.50 mm	0.75 mm	1.00 mm			
	020023	020179	020024	020189	020025			
Rings	A69RK028	A69RK069	A69RK054	A69RK070	A69RK055			
Head	220345	220344 (Comp)			Rear end Cover		Conn Rod	
Crankshaft					Front end Cover			
Bolts	140128 (4)	140151 (4)	140210					
Other Parts	Bush	Base Plate	F Flange Gasket	R Flange Gasket				
	6308C3	220058	010097	010438				

WABCO SERIES

		MAJORSELL PARTS FOR: 911 153 530 0				MAJORSELL REBUILD: 67A146R		
		Users	CUMMINS					
		OE	3944525					
Bore	Drive	Cooling	Weight	Mount	Lube	Water Port	Air Inlet	Air Delivery
85 mm	Non-Through	Water	14 kg	Flange	Engine Oil	¾"	Manifold	M27
Repair Kits	Full Kit	Head Kit	Gasket Kit	Valve Kit	Ess Kit	Valve Plate		
	A67RK058	A67RK058A	A67RK058B	A67RK058C	A67RK058D1	A67RK058V		
Piston	Std	0.25 mm	0.50 mm	0.75 mm	1.00 mm			
	020023	020179	020024	020189	020025			
Rings	A69RK028	A69RK069	A69RK054	A69RK070	A69RK055			
Head	220345	220344 (Comp)			Rear end Cover	220666	Conn Rod	220100
Crankshaft					Front end Cover			
Bolts	140128 (4)	140151 (5)	140210					
Other Parts	Front Bush	Rear Bearing	Base Plate	Front Flange Gasket				
	050207	6308	220058 (2)	010461				

		MAJORSELL PARTS FOR: 911 153 608 0				MAJORSELL REBUILD: 67A157R		
		Users	CUMMINS					
		OE	3103403	3104324	3558163	4952756		
Bore	Drive	Cooling	Weight	Mount	Lube	Water Port	Air Inlet	Air Delivery
85 mm	Through	Water	14 kg	Flange	Engine	3/4"	Manifold	27 mm
Repair Kits	Full Kit	Head Kit	Gasket Kit	Valve Kit	Ess Kit	Valve Plate		
	A67RK109	A67RK109A	A67RK109B	A67RK109C	A67RK109D	A67RK109V		
Piston	Std	0.25 mm	0.50 mm	0.75 mm	1.00 mm			
	020023	020179	020024	020189	020025			
Rings	A69RK028	A69RK069	A69RK054	A69RK070	A69RK055			
Head	220746	220728 (Comp)			Rear end Cover	220666	Conn Rod	220100
Crankshaft	220732				Front end Cover			
Bolts								
Other Parts	Sump Cover	Crank Gear	Rear Bearing	Pump Adapter		Flange Gasket	Flange Gasket	
	220058	220718	6803-C3	220719		010097	010438	

		MAJORSELL PARTS FOR: 911 153 938 0				MAJORSELL REBUILD: 67A164R		
		Users	CUMMINS					
		OE						
Bore	Drive	Cooling	Weight	Mount	Lube	Water Port	Air Inlet	Air Delivery
85 mm	Through	Water	18.5 kg	Flange	Engine Oil	¾ UNF	Flange	M27
Repair Kits	Full Kit	Head Kit	Gasket Kit	Valve Kit	Ess Kit	Valve Plate		
	A67RK058	A67RK058A	A67RK058B	A67RK058C	A67RK058D1	A67RK058V		
Piston	Std	0.25 mm	0.50 mm	0.75 mm	1.00 mm			
	020023	020179	020024	020189	020025			
Rings	A69RK028	A69RK069	A69RK054	A69RK070	A69RK055			
Head	220345	220344 (Comp)			Rear end Cover	220666	Conn Rod	220100
Crankshaft					Front end Cover			
Bolts	140128 (4)	140151 (5)	140138 (4)	140199 (5)				
Other Parts	Front Bush	Rear Bearing	Base Plate	O Ring	Front Flange Gasket			
	050253	6308	220058	RM1150-30V	3685614			

WABCO SERIES

		MAJORSELL PARTS FOR: 911 154 500 0				MAJORSELL REBUILD: 67A014R		
		Users	CUMMINS					
		OE						
Bore	Drive	Cooling	Weight	Mount	Lube	Water Port	Air Inlet	Air Delivery
75 mm	Through	Water	17 kg	Flange	Engine Oil	¾ - 16 UNF	Manifold	M27
Repair Kits	Full Kit	Head Kit	Gasket Kit	Valve Kit	Ess Kit	Cooling Plate		
	A67RK070	A67RK070A	A67RK070B	A67RK070C	A67RK062D	A67RK070CP		
Piston	Std	0.25 mm	0.50 mm	0.75 mm	1.00 mm			
	020067	020176	020076	020196				
Rings	A67RK013	A67RK101	A67RK014	A67RK102				
Head	220355	220354 (Comp)			Rear end Cover	220666	Conn Rod	220459
Crankshaft					Front end Cover			
Bolts	140128 (3)	140151 (2)	140138 (4)	140199 (2)				
Other Parts	Front Bush	Rear Bearing	Rear End Gasket	O Ring	Ball Bearing	Safety Valve Spring		F Flange Gasket
	050207	6308	010361	RM0840-30V	140207	040163		3929751

		MAJORSELL PARTS FOR: 911 154 510 0				MAJORSELL REBUILD: 67A059R		
		Users	CUMMINS					
		OE	5286964					
Bore	Drive	Cooling	Weight	Mount	Lube	Water Port	Air Inlet	Air Delivery
75 mm	Through	Water	14 kg	Flange	Engine Oil	¾ - 16 UNF	M27	M27
Repair Kits	Full Kit	Head Kit	Gasket Kit	Valve Kit	Ess Kit	Valve Plate	Cooling Plate	
	A67RK070	A67RK070A	A67RK070B	A67RK070C	A67RK062D	A67RK070V	A67RK070CP	
Piston	Std	0.25 mm	0.50 mm	0.75 mm	1.00 mm			
	020067	020176	020076	020196	020095			
Rings	A67RK013	A67RK101	A67RK014	A67RK102	A67RK023			
Head	220349	220348 (Comp)			Rear end Cover	220666	Conn Rod	220459
Crankshaft					Front end Cover			
Bolts	140143 (4)	140151 (2)	140128 (4)	140197 (2)				
Other Parts	Front Bush	Rear Bearing	Base Plate	Gasket	O Ring	Front Flange Gasket		Seal
	050207	6308	220058	010361	RM0840-30V	4896897		RM0745-30

		MAJORSELL PARTS FOR: 911 154 513 0				MAJORSELL REBUILD: 67A177R		
		Users	CUMMINS					
		OE	4346293					
Bore	Drive	Cooling	Weight	Mount	Lube	Water Port	Air Inlet	Air Delivery
75 mm	Through	Water	17 kg	Flange	Engine Oil	¾ - 16 UNF	Manifold	M27
Repair Kits	Full Kit	Head Kit	Gasket Kit	Valve Kit	Ess Kit	Valve Plate	Cooling Plate	
	A67RK070	A67RK070A	A67RK070B	A67RK070C	A67RK062D	A67RK070V	A67RK070CP	
Piston	Std	0.25 mm	0.50 mm	0.75 mm	1.00 mm			
	020067	020176	020076	020196	020095			
Rings	A67RK013	A67RK101	A67RK014	A67RK102	A67RK023			
Head	220355	220354 (Comp)			Rear end Cover	220666	Conn Rod	220667
Crankshaft					Front end Cover			
Bolts	140128 (3)	140151 (2)	140138 (4)	140199 (2)				
Other Parts	Front Bush	Rear Bearing	Rear End Gasket	O Ring	Base Plate	Front Flange Gasket		Pump Adapter
	050253	6308	010361	RM0840-30V	220058	3929751		220725

WABCO SERIES

		MAJORSELL PARTS FOR: 911 154 515 0				MAJORSELL REBUILD: 67A179R		
		Users	CUMMINS					
		OE						
Bore	Drive	Cooling	Weight	Mount	Lube	Water Port	Air Inlet	Air Delivery
75 mm	Through	Water	17 kg	Flange	Engine Oil	¾ - 16 UNF	Manifold	M27
Repair Kits	Full Kit	Head Kit	Gasket Kit	Valve Kit	Ess Kit	Valve Plate	Cooling Plate	
	A67RK070	A67RK070A	A67RK070B	A67RK070C	A67RK062D	A67RK070V	A67RK070CP	
Piston	Std	0.25 mm	0.50 mm	0.75 mm	1.00 mm			
	020067	020176	020076	020196	020095			
Rings	A67RK013	A67RK101	A67RK014	A67RK102	A67RK023			
Head	220355	220354 (Comp)			Rear end Cover	220666	Conn Rod	220667
Crankshaft					Front end Cover			
Bolts	140128 (3)	140151 (2)	140138 (4)	140199 (2)				
Other Parts	Front Bush	Rear Bearing	Rear End Gasket	Ball Bearing	Base Plate	Safety Valve Spring	Front Gasket	O Ring
	050253	6308	010361	140207	220058	040163	3929751	RM0840-30V

		MAJORSELL PARTS FOR: 911 501 016 0				MAJORSELL REBUILD: 67A004R		
		Users	DAF					
		OE	667441					
Bore	Drive	Cooling	Weight	Mount	Lube	Water Port	Air Inlet	Air Delivery
85 mm	Through	Air		Flange				
Repair Kits	Full Kit	Head Kit	Gasket Kit	Valve Kit	Ess Kit	Cooling Plate		
	A67RK005	A67RK005A	A67RK005B	A67RK005C	A67RK062D			
Piston	Std	0.25 mm	0.50 mm	0.75 mm	1.00 mm			
	020023	020179	020024	020189	020025			
Rings	A69RK028	A69RK069	A69RK054	A69RK070	A69RK055			
Head					Rear end Cover		Conn Rod	
Crankshaft					Front end Cover			
Bolts								
Other Parts								

		MAJORSELL PARTS FOR: 911 501 059 0				MAJORSELL REBUILD:		
		Users	DENNIS					
		OE						
Bore	Drive	Cooling	Weight	Mount	Lube	Water Port	Air Inlet	Air Delivery
85 mm	Through		17.5 kg	Flange				
Repair Kits	Full Kit	Head Kit	Gasket Kit	Valve Kit	Valve Plate	Cooling Plate		
	A67RK005	A67RK005A	A67RK005B	A67RK005C				
Piston	Std	0.25 mm	0.50 mm	0.75 mm	1.00 mm			
	020023	020179	020024	020189	020025			
Rings	A69RK028	A69RK069	A69RK054	A69RK070	A69RK055			
Head					Rear end Cover		Conn Rod	220066
Crankshaft					Front end Cover			
Bolts	140196 (1)							
Other Parts	Rear Bearing	Front Bush	Inserts					
	6307	050186	050102 (2)					

WABCO SERIES

		MAJORSELL PARTS FOR: 911 503 051 0				MAJORSELL REBUILD: 67A037R			
		Users	DAF						
		OE	0280408						
Bore	Drive	Cooling	Weight	Mount	Lube	Water Port	Air Inlet	Air Delivery	
75 mm	Non-Through	Water	14 kg	Flange	Engine Oil	M14	M26	M26	
Repair Kits	Full Kit	Head Kit	Gasket Kit	Valve Kit	Valve Plate	Cooling Plate			
	A67RK017	A67RK017A	A67RK017B	A67RK017C					
Piston	Std	0.25 mm	0.50 mm	0.75 mm	1.00 mm				
	020067	020176	020076	020196	020095				
Rings	A67RK013	A67RK101	A67RK014	A67RK102	A67RK023				
Head					Rear end Cover		Conn Rod		
Crankshaft		140019 (Nut)			Front end Cover				
Bolts	140195 (6)	140132 (2)	140137 (6)	140199 (2)	140127 (4)	140138 (4)			
Other Parts	Front & Rear Bush		Inserts	Thrust Washer					
	050192		050159	050191 (2)					

		MAJORSELL PARTS FOR: 911 504 051 0				MAJORSELL REBUILD: 67A048R			
		Users	DAF						
		OE	1373081	0762788					
Bore	Drive	Cooling	Weight	Mount	Lube	Water Port	Air Inlet	Air Delivery	
75 mm	Non-Through			Flange					
Repair Kits	Full Kit	Head Kit	Gasket Kit	Valve Kit	Valve Plate	Cooling Plate			
	A67RK025	A67RK025A	A67RK025B	A67RK025C	A67RK025V				
Piston	Std	0.25 mm	0.50 mm	0.75 mm	1.00 mm				
	020067	020176	020076	020196	020095				
Rings	A67RK013	A67RK101	A67RK014	A67RK102	A67RK023				
Head					Rear end Cover		Conn Rod	220307	
Crankshaft		140129 (Nut)			Front end Cover				
Bolts	140171 (6)	140137 (6)	140124 (4)	140138 (4)					
Other Parts	Front Bush								
	050199								

		MAJORSELL PARTS FOR: 911 504 052 0				MAJORSELL REBUILD: 67A018R			
		Users	DAF						
		OE	0762788						
Bore	Drive	Cooling	Weight	Mount	Lube	Water Port	Air Inlet	Air Delivery	
75 mm	Non-Through	Water	18 kg	Flange	Engine Oil	M22	M26	M26	
Repair Kits	Full Kit	Head Kit	Gasket Kit	Valve Kit	Valve Plate	Cooling Plate			
	A67RK025	A67RK025A	A67RK025B	A67RK025C	A67RK025V				
Piston	Std	0.25 mm	0.50 mm	0.75 mm	1.00 mm				
	020067	020176	020076	020196	020095				
Rings	A67RK013	A67RK101	A67RK014	A67RK102	A67RK023				
Head	220812	220811 (Comp)			Rear end Cover	220309	Conn Rod	220307	
Crankshaft	220308	140129 (Pin)			Front end Cover				
Bolts	140171 (6)	140184 (2)	140137 (6)	140138 (4)	140125 (8)	140315 (2)			
Other Parts	Front & Rear Bush		Inserts	O Ring	Crankcase				
	050199		050159 (2)	RM1250-30V	220555				

WABCO SERIES

		MAJORSELL PARTS FOR: 911 504 056 0				MAJORSELL REBUILD: 67A019R		
		Users	DAF					
		OE	1243571					
Bore	Drive	Cooling	Weight	Mount	Lube	Water Port	Air Inlet	Air Delivery
75 mm	Non-Through	Water	18 kg	Flange	Engine Oil	M14	M26	M26
Repair Kits	Full Kit	Head Kit	Gasket Kit	Valve Kit	Valve Plate	Cooling Plate		
	A67RK056	A67RK056A	A67RK056B	A67RK017C	A67RK056V			
Piston	Std	0.25 mm	0.50 mm	0.75 mm	1.00 mm			
	020067	020176	020076	020196	020095			
Rings	A67RK013	A67RK101	A67RK014	A67RK102	A67RK023			
Head	220496	220310 (Comp)			Rear end Cover	220309	Conn Rod	220311
Crankshaft	220308	140129 (Nut)			Front end Cover			
Bolts	140315 (2)							
Other Parts	Front Bush	Crankcase						
	050199	220555						

		MAJORSELL PARTS FOR: 911 504 060 0				MAJORSELL REBUILD: 67A009R		
		Users	DAF					
		OE	1298052					
Bore	Drive	Cooling	Weight	Mount	Lube	Water Port	Air Inlet	Air Delivery
75 mm	Non-Through	Water	15 kg	Flange	Engine Oil	M14	M26	M26
Repair Kits	Full Kit	Head Kit	Gasket Kit	Valve Kit	Valve Plate	Cooling Plate		
	A67RK056	A67RK056A	A67RK056B	A67RK056C	A67RK056V			
Piston	Std	0.25 mm	0.50 mm	0.75 mm	1.00 mm			
	020067	020176	020076	020196	020095			
Rings	A67RK013	A67RK101	A67RK014	A67RK102	A67RK023			
Head	220496	220310 (Comp)			Rear end Cover	220549	Conn Rod	220311 (2)
Crankshaft	220312	140129 (Pin)			Front end Cover			
Bolts	140171 (6)	140130 (2)	140137 (6)	140124 (2)	140138 (4)	140215 (2)		
Other Parts	Front & Rear Bush		O Ring	Base Plate	Crankcase			
	050199		BS250S	220058 (2)	220442			

		MAJORSELL PARTS FOR: 911 504 501 0				MAJORSELL REBUILD: 67A029R		
		Users	DAF					
		OE	1310523					
Bore	Drive	Cooling	Weight	Mount	Lube	Water Port	Air Inlet	Air Delivery
75 mm	Non-Through	Water	18 kg	Flange	Engine Oil	M14	M26	M26
Repair Kits	Full Kit	Head Kit	Gasket Kit	Valve Kit	Ess Kit	Valve Plate	Cooling Plate	
	A67RK054	A67RK054A	A67RK054B	A67RK054C	A67RK054D	A67RK054V	A67RK054CP	
Piston	Std	0.25 mm	0.50 mm	0.75 mm	1.00 mm			
	020067	020176	020076	020196	020095			
Rings	A67RK013	A67RK101	A67RK014	A67RK102	A67RK023			
Head	220494	220316 (Comp)			Rear end Cover		Conn Rod	220315 (2)
Crankshaft	220314	140129 (Pin)			Front end Cover			
Bolts	140149 (6)	140151 (2)	140138 (6)	140199 (2)				
Other Parts	Front Bearing	Rear Bush	Base Plate	O Ring	Liner Sleeve			
	6307	050195	220058 (2)	BS250S	020987			

WABCO SERIES

	MAJORSELL PARTS FOR: 911 504 503 0					MAJORSELL REBUILD: 67A045R		
	Users	DAF						
	OE	1451651						
Bore	Drive	Cooling	Weight	Mount	Lube	Water Port	Air Inlet	Air Delivery
75 mm	Non-Through	Water	18 kg	Flange	Engine Oil	M14	M26	M26
Repair Kits	Full Kit	Head Kit	Gasket Kit	Valve Kit	Ess Kit	Valve Plate	Cooling Plate	
	A67RK054	A67RK054A	A67RK054B	A67RK054C	A67RK082D	A67RK054V	A67RK054CP	
Piston	Std	0.25 mm	0.50 mm	0.75 mm	1.00 mm			
	020067	020176	020076	020196	020095			
Rings	A67RK013	A67RK101	A67RK014	A67RK102	A67RK023			
Head	220494	220316 (Comp)			Rear end Cover		Conn Rod	220315 (2)
Crankshaft	220314	140129 (Pin)			Front end Cover			
Bolts	140149 (6)	140151 (2)	140138 (6)	140199 (2)				
Other Parts	Front Bearing	Rear Bush	Base Plate	O Ring	Liner Sleeve			
	6307	050195	220058 (2)	BS250S	020987			

	MAJORSELL PARTS FOR: 911 504 504 0					MAJORSELL REBUILD: 67A038R		
	Users	DAF						
	OE	1604420		1451651				
Bore	Drive	Cooling	Weight	Mount	Lube	Water Port	Air Inlet	Air Delivery
75 mm	Non-Through	Water	18 kg	Flange	Engine Oil	M14	M26	M26
Repair Kits	Full Kit	Head Kit	Gasket Kit	Valve Kit	Ess Kit	Valve Plate	Cooling Plate	
	A67RK082	A67RK082A	A67RK082B	A67RK082C	A67RK082D	A67RK082V	A67RK082CP	
Piston	Std	0.25 mm	0.50 mm	0.75 mm	1.00 mm			
	020067	020176	020076	020196	020095			
Rings	A67RK013	A67RK101	A67RK014	A67RK102	A67RK023			
Head	220498	220497 (Comp)			Rear end Cover		Conn Rod	220315 (2)
Crankshaft	220314	140129 (Pin)			Front end Cover			
Bolts	140149 (6)	140151 (2)	140138 (6)	140199 (2)				
Other Parts	Front Bearing	Rear Bush	O Ring	Base Plate	Liner Sleeve			
	6307	050195	BS250S	220058 (2)	020987			

	MAJORSELL PARTS FOR: 911 504 506 0					MAJORSELL REBUILD: 67A057R		
	Users	DAF						
	OE	1736785		1628444	1451651	1604420		
Bore	Drive	Cooling	Weight	Mount	Lube	Water Port	Air Inlet	Air Delivery
75 mm	Non-Through	Water	18.5 kg	Flange	Engine Oil	M14	M26	M26
Repair Kits	Full Kit	Head Kit	Gasket Kit	Valve Kit	Ess Kit	Valve Plate	Cooling Plate	
	A67RK082	A67RK082A	A67RK082B	A67RK082C	A67RK082D	A67RK082V	A67RK082CP	
Piston	Std	0.25 mm	0.50 mm	0.75 mm	1.00 mm			
	020067	020176	020076	020196	020095			
Rings	A67RK013	A67RK101	A67RK014	A67RK102	A67RK023			
Head	220338	220249 (Comp)			Rear end Cover		Conn Rod	220315 (2)
Crankshaft	220314	140129 (Pin)			Front end Cover			
Bolts	140149 (6)	140151 (2)	140138 (6)	140199 (2)				
Other Parts	Front Bearing	Rear Bush	Blanking Plug	Liner Sleeve	Valve Spring	Valve Ball	Base Plate	
	6307	050195	140178	020987 (2)	040163	140207	220058 (2)	

WABCO SERIES

		MAJORSELL PARTS FOR: 911 505 150 0				MAJORSELL REBUILD: 67A001R		
		Users	DAF	VOLVO	RVI			
		OE	1506365	1626060	5003460			
Bore	Drive	Cooling	Weight	Mount	Lube	Water Port	Air Inlet	Air Delivery
85 mm	Non-Through	Water	17 kg	Flange	Engine Oil	M16	M26	M26
Repair Kits	Full Kit	Head Kit	Gasket Kit	Valve Kit	Valve Plate	Cooling Plate		
	A67RK019	A67RK019A	A67RK019B	A67RK019C	A67RK019V			
Piston	Std	0.25 mm	0.50 mm	0.75 mm	1.00 mm			
	020023	020179	020024	020189	020025			
Rings	A69RK028	A69RK069	A69RK054	A69RK070	A69RK055			
Head	220273	220126 (Comp)			Rear end Cover	220222	Conn Rod	220224 (2)
Crankshaft	220131	140016 (Nut)			Front end Cover			
Bolts	140136 (6)	140132 (2)	140139 (2)	140199 (2)	140137 (6)	140124 (4)	140138 (4)	
Other Parts	Front Bearing	Rear Bush	Base Plate	O Ring				
	6307	050278	220058 (2)	RM1150-30V				

		MAJORSELL PARTS FOR: 911 505 151 0				MAJORSELL REBUILD: 67A002R		
		Users	VOLVO					
		OE	3037344					
Bore	Drive	Cooling	Weight	Mount	Lube	Water Port	Air Inlet	Air Delivery
85 mm	Non-Through	Water	17 kg	Flange	Engine Oil	M16	M26	M26
Repair Kits	Full Kit	Head Kit	Gasket Kit	Valve Kit	Valve Plate	Cooling Plate		
	A67RK019	A67RK019A	A67RK019B	A67RK019C	A67RK019V			
Piston	Std	0.25 mm	0.50 mm	0.75 mm	1.00 mm			
	020023	020179	020024	020189	020025			
Rings	A69RK028	A69RK069	A69RK054	A69RK070	A69RK055			
Head	220273	220126 (Comp)			Rear end Cover	220222	Conn Rod	220224 (2)
Crankshaft	220131	140016 (Nut)			Front end Cover			
Bolts	140136 (6)	140132 (2)	140139 (2)	140138 (2)	140137 (6)	140124 (4)	140138 (4)	
Other Parts	Front Bearing	Rear Bush	Base Plate	O Ring				
	6307	050278	220058 (2)	RM1150-30V				

		MAJORSELL PARTS FOR: 911 505 154 0				MAJORSELL REBUILD: 67A035R		
		Users	DAF	DENNIS	CUMMINS	VOLVO		
		OE	67A035R					
Bore	Drive	Cooling	Weight	Mount	Lube	Water Port	Air Inlet	Air Delivery
85 mm	Through	Water	19 kg	Flange	Engine Oil	M16	M26	M26
Repair Kits	Full Kit	Head Kit	Gasket Kit	Valve Kit	Valve Plate	Cooling Plate		
	A67RK019	A67RK019A	A67RK019B	A67RK019C	A67RK019V			
Piston	Std	0.25 mm	0.50 mm	0.75 mm	1.00 mm			
	020023	020179	020024	020189	020025			
Rings	A69RK028	A69RK069	A69RK054	A69RK070	A69RK055			
Head	220273	220126 (Comp)			Rear end Cover		Conn Rod	220224 (2)
Crankshaft					Front end Cover			
Bolts	140136 (6)	140132 (2)	140139 (2)	140138 (2)	140137 (6)	140135 (5)	140199 (2)	
Other Parts	Front Bearing	Base Plate	O Ring	Liner Sleeve				
	6307	220058 (2)	RM1150-30V	020986 (2)				

WABCO SERIES

		MAJORSELL PARTS FOR: 911 506 054 0				MAJORSELL REBUILD: 67A058R		
		Users	IVECO	DAF				
		OE	98427043					
Bore	Drive	Cooling	Weight	Mount	Lube	Water Port	Air Inlet	Air Delivery
75 mm	Non-Through	Water	15.5 kg	Flange		M16		
Repair Kits	Full Kit	Head Kit	Gasket Kit	Valve Kit	Valve Plate	Cooling Plate		
	A67RK049	A67RK049A	A67RK049B	A67RK017C				
Piston	Std	0.25 mm	0.50 mm	0.75 mm	1.00 mm			
	020067	020176	020076	020196	020095			
Rings	A67RK013	A67RK101	A67RK014	A67RK102	A67RK023			
Head					Rear end Cover		Conn Rod	
Crankshaft		140015 (Nut)			Front end Cover			
Bolts								
Other Parts	Front Bush	Thrust Washer		Base Plate				
	050192	050191		220058 (2)				

		MAJORSELL PARTS FOR: 911 506 505 0				MAJORSELL REBUILD: 67A140R		
		Users	DAF	IVECO				
		OE	1518142	500329472				
Bore	Drive	Cooling	Weight	Mount	Lube	Water Port	Air Inlet	Air Delivery
75 mm	Through	Water	15.5 Kg	Flange	Engine Oil	Manifold	Manifold	Manifold
Repair Kits	Full Kit	Head Kit	Gasket Kit	Valve Kit	Mounting Kit	Cooling Plate		
	A67RK050	A67RK050A	A67RK050B	A67RK050C	A67RK050F			
Piston	Std	0.25 mm	0.50 mm	0.75 mm	1.00 mm			
	020067	020176	020076	020196	020095			
Rings	A67RK013	A67RK101	A67RK014	A67RK102	A67RK023			
Head					Rear end Cover		Conn Rod	
Crankshaft		140015 (Nut)			Front end Cover			
Bolts	140131 (6)	140139 (3)	140138 (6)	140199 (3)	140124 (4)	140138 (4)		
Other Parts	Front Bush	Front Flange Gasket		Base Plate				
	050158	010364		220058 (2)				

		MAJORSELL PARTS FOR: 911 514 001 0				MAJORSELL REBUILD: 67A172R		
		Users	MAN					
		OE	51541017254					
Bore	Drive	Cooling	Weight	Mount	Lube	Water Port	Air Inlet	Air Delivery
85mm	Through	Water	20kg	Flange	Engine	14mm	26mm	26mm
Repair Kits	Full Kit	Head Kit	Gasket Kit	Valve Kit	Valve Plate	Valve Plate	Cooling Plate	
	A67RK071	A67RK071A	A67RK071B	A67RK071C	A67RK071V	A67RK071V1	A67RK071CP	
Piston	Std	0.25 mm	0.50 mm	0.75 mm	1.00 mm			
	020023		020024		020025			
Rings	A69RK028		A69RK054		A69RK055			
Head	220165	220288 (Comp)	220356 (Comp)		Rear end Cover	220681	Conn Rod	220696 (2)
Crankshaft		140016 (Nut)			Front end Cover			
Bolts	140104 (8)	140144 (2)	140138 (8)	140148 (2)	140124 (4)	140138 (4)		
Other Parts	Front Bush	Cover Seal	Cover Seal	Sump Gasket	Plug			
	050199	RM0880-30V	RM0880-30V	010380	080038			

WABCO SERIES

		MAJORSELL PARTS FOR: 911 515 016 0				MAJORSELL REBUILD: 67A226R			
		Users	CUMMINS						
		OE	3103405	3099666	4972994				
Bore	Drive	Cooling	Weight	Mount	Lube	Water Port	Air Inlet	Air Delivery	
85 mm	Through	Water		Flange	Engine Oil				
Repair Kits	Full Kit	Head Kit	Gasket Kit	Valve Kit	Valve Plate	Cooling Plate			
	A67RK095	A67RK095A	A67RK095B	A67RK095C	A67RK095V				
Piston	Std	0.25 mm	0.50 mm	0.75 mm	1.00 mm				
	020023	020179	020024	020189	020025				
Rings	A69RK028	A69RK069	A69RK054	A69RK070	A69RK055				
Head	220743	220744 (Comp)			Rear end Cover	220085	Conn Rod	220100 (2)	
Crankshaft					Front end Cover				
Bolts									
Other Parts	Rear Bearing	Rear Dog Drive	Sump Cov Seals		Sump Cover				
	6308C3	220668		RM0550-25	220058				

		MAJORSELL PARTS FOR: 911 516 010 0				MAJORSELL REBUILD: 67A165R			
		Users	CUMMINS						
		OE	4945947	5286681					
Bore	Drive	Cooling	Weight	Mount	Lube	Water Port	Air Inlet	Air Delivery	
75mm	Non-through	Water	15 kg	Flange	Engine	3/4 UNF	Flange	27 mm	
Repair Kits	Full Kit	Head Kit	Gasket Kit	Valve Kit	Valve Plate	Cooling Plate			
	A67RK091	A67RK091A	A67RK091B	A67RK091C	A67RK091V	A67RK091CP			
Piston	Std	0.25 mm	0.50 mm	0.75 mm	1.00 mm				
	020067	020176	020076	020196	020095				
Rings	A67RK013	A67RK101	A67RK014	A67RK102	A67RK023				
Head	220380	220369 (Comp)			Rear end Cover	220666	Conn Rod	220459	
Crankshaft	220458				Front end Cover				
Bolts	140128 (4)	140151 (3)							
Other Parts	Front Bush	Rear Sline Drive	Sump Cover	Front Flange Gasket		Sump O Ring	Valve Reed	Reed Gasket	
	050253	220668	220461	3685614		BS139	060270 (2)	010399 (2)	

		MAJORSELL PARTS FOR: 911 553 003 0				MAJORSELL REBUILD: 67A132R			
		Users	MERCEDES						
		OE	4571302015						
Bore	Drive	Cooling	Weight	Mount	Lube	Water Port	Air Inlet	Air Delivery	
85 mm	Non-through	Water	20 kg	Flange	Engine Oil	M16	M30	M26	
Repair Kits	Full Kit	Head Kit	Gasket Kit	Valve Kit	Ess Kit	Valve Plate			
	A67RK073	A67RK073A	A67RK073B	A67RK073C	A67RK073D	A67RK073V			
Piston	Std	0.25 mm	0.50 mm	0.75 mm	1.00 mm				
	020023	020179	020024	020189	020025				
Rings	A69RK028	A69RK069	A69RK054	A69RK070	A69RK055				
Head	220160	220205 (Comp)			Rear end Cover	220093	Conn Rod	220150 (2)	
Crankshaft	220777	140203 (Nut)			Front end Cover				
Bolts	140143 (6)	140126 (2)	140138 (6)	140124 (4)					
Other Parts	Front Bush	Base Plate	Liner Sleeve	Front End Gasket					
	050280	220058 (2)	020985 (2)	010421		220323			

WABCO SERIES

		MAJORSELL PARTS FOR: 911 553 007 0				MAJORSELL REBUILD: 67A133R			
		Users	MERCEDES						
		OE	9125530030	4571306615					
Bore	Drive	Cooling	Weight	Mount	Lube	Water Port	Air Inlet	Air Delivery	
85 mm	Non-Through	Water	19 kg	Flange	Engine Oil	M16	M30	M26	
Repair Kits	Full Kit	Head Kit	Gasket Kit	Valve Kit	Ess Kit	Valve Plate			
	A67RK073	A67RK073A	A67RK073B	A67RK073C	A67RK073D	A67RK073V			
Piston	Std	0.25 mm	0.50 mm	0.75 mm	1.00 mm				
	020023	020179	020024	020189	020025				
Rings	A69RK028	A69RK069	A69RK054	A69RK070	A69RK055				
Head	220160	220205 (Comp)			Rear end Cover	220093	Conn Rod	220150 (2)	
Crankshaft	220777	140203 (Nut)			Front end Cover				
Bolts	140143 (6)	140126 (2)	140138 (6)	140129 (4)	140387				
Other Parts	Front Bush	Base Plate	Liner Sleeve	Gasket	Drive Gear				
	050280	220058 (2)	020985 (2)	010421	220323				

		MAJORSELL PARTS FOR: 911 553 100 0				MAJORSELL REBUILD: 67A079R			
		Users	MERCEDES						
		OE	4571301215						
Bore	Drive	Cooling	Weight	Mount	Lube	Water Port	Air Inlet	Air Delivery	
85 mm	Non-Through	Water	20 kg	Flange	Engine Oil	M16	M30	M26	
Repair Kits	Full Kit	Head Kit	Gasket Kit	Valve Kit	Ess Kit	Valve Plate	Cooling Plate		
	A67RK073	A67RK073A	A67RK073B	A67RK073C	A67RK073D	A67RK073V	A67RK073CP		
Piston	Std	0.25 mm	0.50 mm	0.75 mm	1.00 mm				
	020023	020179	020024	020189	020025				
Rings	A69RK028	A69RK069	A69RK054	A69RK070	A69RK055				
Head	220247	220164 (Comp)			Rear end Cover	220093	Conn Rod		
Crankshaft	220141(L/H)	140203 (Nut)			Front end Cover				
Bolts	140143 (6)	140126 (2)	140138 (6)	140129 (4)					
Other Parts	Front Bush	Base Plate	Liner Sleeve	Drive Gear	Gasket	O Ring	O Ring		
	050213	220058 (2)	020985 (2)	220180	010421	RM0170-30V	RM0840-30V (2)		

* Replaced by 911 553 103 0

		MAJORSELL PARTS FOR: 911 553 101 0				MAJORSELL REBUILD: 67A130R			
		Users	MERCEDES						
		OE	4571301915						
Bore	Drive	Cooling	Weight	Mount	Lube	Water Port	Air Inlet	Air Delivery	
85 mm		Water	20 kg	Flange		M16	M30	M26	
Repair Kits	Full Kit	Head Kit	Gasket Kit	Valve Kit	Ess Kit	Valve Plate			
	A67RK073	A67RK073A	A67RK073B	A67RK073C	A67RK073D	A67RK073V			
Piston	Std	0.25 mm	0.50 mm	0.75 mm	1.00 mm				
	020023	020179	020024	020189	020025				
Rings	A69RK028	A69RK069	A69RK054	A69RK070	A69RK055				
Head		220164 (Comp)			Rear end Cover		Conn Rod		
Crankshaft	220141				Front end Cover				
Bolts									
Other Parts	Front Bush	Liner Sleeve							
	050213	020985							

* Replaced by 911 553 104 0

WABCO SERIES

		MAJORSELL PARTS FOR: 911 553 103 0				MAJORSELL REBUILD: 67A077R			
		Users	MERCEDES						
		OE	4571302215						
Bore	Drive	Cooling	Weight	Mount	Lube	Water Port	Air Inlet	Air Delivery	
85 mm	Through	Water	22 kg	Flange	Engine Oil	M16	M30	M26	
Repair Kits	Full Kit	Head Kit	Gasket Kit	Valve Kit	Ess Kit	Valve Plate	Cooling Plate		
	A67RK073	A67RK073A	A67RK073B	A67RK073C	A67RK073D	A67RK073V	A67RK073CP		
Piston	Std	0.25 mm	0.50 mm	0.75 mm	1.00 mm				
	020023	020179	020024	020189	020025				
Rings	A69RK028	A69RK069	A69RK054	A69RK070	A69RK055				
Head	220247	220164 (Comp)			Rear end Cover	220093	Conn Rod	220150 (2)	
Crankshaft	220141(L/H)	140203 (Nut)			Front end Cover				
Bolts	140143 (6)	140126 (2)	140138 (6)	140199 (2)	140124 (4)	140138 (4)			
Other Parts	Base Plate	Gasket	Drive Gear	Front Bush	O Ring	O Ring			
	220058 (2)	010421	220180	050213	RM0170-30V	RM0840-30V (2)			

* Replaced by 912 510 103 0

		MAJORSELL PARTS FOR: 911 553 105 0				MAJORSELL REBUILD: 67A131R			
		Users	MERCEDES						
		OE	4571302715						
Bore	Drive	Cooling	Weight	Mount	Lube	Water Port	Air Inlet	Air Delivery	
85 mm	Through	Water	22 kg	Flange	Engine Oil	M16	M30	M26	
Repair Kits	Full Kit	Head Kit	Gasket Kit	Valve Kit	Ess Kit	Valve Plate	Cooling Plate		
	A67RK073	A67RK073A	A67RK073B	A67RK073C	A67RK073D	A67RK073V	A67RK073CP		
Piston	Std	0.25 mm	0.50 mm	0.75 mm	1.00 mm				
	020023	020179	020024	020189	020025				
Rings	A69RK028	A69RK069	A69RK054	A69RK070	A69RK055				
Head	220247	220164 (Comp)			Rear end Cover	220093	Conn Rod	220150	
Crankshaft	220141(L/H)	140203 (Nut)			Front end Cover				
Bolts	140143 (6)	140126 (2)	140199 (2)	140124 (4)					
Other Parts	Front Bush	Base Plate	Sealing Ring	Drive Gear	O Ring	Liner Sleeve			
	050280	220058 (2)	160116	220180	RM0840-30V (2)	020985 (2)			

 NO IMAGE AVAILABLE		MAJORSELL PARTS FOR: 911 553 200 0				MAJORSELL REBUILD: 67A080R			
		Users	MERCEDES						
		OE	4571302915						
Bore	Drive	Cooling	Weight	Mount	Lube	Water Port	Air Inlet	Air Delivery	
85 mm	Non-Through	Water	22 kg	Flange	Engine Oil	M16	M30	M26	
Repair Kits	Full Kit	Head Kit	Gasket Kit	Valve Kit	Ess Kit	Valve Plate	Cooling Plate		
	A67RK073	A67RK073A	A67RK073B	A67RK073C	A67RK073D	A67RK073V1	A67RK073CP		
Piston	Std	0.25 mm	0.50 mm	0.75 mm	1.00 mm				
	020023	020179	020024	020189	020025				
Rings	A69RK028	A69RK069	A69RK054	A69RK070	A69RK055				
Head	220247	220364 (Comp)			Rear end Cover	220093	Conn Rod		
Crankshaft	220141(L/H)	140203 (Nut)			Front end Cover				
Bolts	140143 (6)	140126 (2)	140199 (2)	140124 (4)	140138(4)				
Other Parts	Front Bush	Drive Gear	Base Plate	Liner Sleeve	Seal	O Ring			
	050213	220180	220058 (2)	020985 (2)	160116	RM0840-30V (2)			

WABCO SERIES

		MAJORSELL PARTS FOR: 911 553 203 0				MAJORSELL REBUILD:			
		Users	MERCEDES						
		OE	4571304715						
Bore	Drive	Cooling	Weight	Mount	Lube	Water Port	Air Inlet	Air Delivery	
85 mm		Water	21 kg			M16	M26	M26	
Repair Kits	Full Kit	Head Kit	Gasket Kit	Valve Kit	Valve Plate	Cooling Plate			
	A67RK073	A67RK073A	A67RK073B	A67RK073C	A67RK073V1				
Piston	Std	0.25 mm	0.50 mm	0.75 mm	1.00 mm				
	020023	020179	020024	020189	020025				
Rings	A69RK028	A69RK069	A69RK054	A69RK070	A69RK055				
Head	220247	220364 (Comp)			Rear end Cover	220093	Conn Rod	220150	
Crankshaft	220141				Front end Cover				
Bolts									
Other Parts	Front Bush	Liner Sleeve							
	050213	020985							

* Replaced by 912 510 200 0

WABCO SERIES

		MAJORSELL PARTS FOR: 912 112 000 0				MAJORSELL REBUILD: 67A230R			
		Users	VOLVO						
		OE	20451727						
Bore	Drive	Cooling	Weight	Mount	Lube	Water Port	Air Inlet	Air Delivery	
85 mm	Non-Through	Water	15 kg	Flange	Engine Oil	M16	Manifold	M26	
Repair Kits	Full Kit	Head Kit	Gasket Kit	Valve Kit	Ess Kit	Valve Plate	Cooling Plate		
	A67RK092	A67RK092A	A67RK092B	A67RK067C	A67RK062D	A67RK092V	A67RK092CP		
Piston	Std	0.25 mm	0.50 mm	0.75 mm	1.00 mm				
	020023	020179	020024	020189	020025				
Rings	A69RK028	A69RK069	A69RK054	A69RK070	A69RK055				
Head	220276	220275 (Comp)			Rear end Cover	220187	Conn Rod	220100	
Crankshaft	220446	140016 (Nut)			Front end Cover				
Bolts	140128 (4)	140144 (4)	140138 (8)						
Other Parts	Front Housing	Rear Bearing	Circlip	Base Plate	Liner Sleeve	O Ring			
	220248	050249	130013	220058	020984	RM1650-30V			

		MAJORSELL PARTS FOR: 912 112 001 0				MAJORSELL REBUILD: 67A239R			
		Users	SCANIA						
		OE	20451727						
Bore	Drive	Cooling	Weight	Mount	Lube	Water Port	Air Inlet	Air Delivery	
85 mm	Non Through	Water	15 kg	Flange	Engine Oil	M16	Manifold	M26	
Repair Kits	Full Kit	Head Kit	Gasket Kit	Valve Kit	Ess Kit	Valve Plate	Cooling Plate		
	A67RK092	A67RK092A	A67RK092B	A67RK067C	A67RK062D	A67RK092V	A67RK092CP		
Piston	Std	0.25 mm	0.50 mm	0.75 mm	1.00 mm				
	020023	020179	020024	020189	020025				
Rings	A69RK028	A69RK069	A69RK054	A69RK070	A69RK055				
Head	220276	220275 (Comp)			Rear end Cover	220187	Conn Rod	220100	
Crankshaft	220446	140016 (Nut)			Front end Cover				
Bolts	140128 (4)	140144 (4)	140138 (8)						
Other Parts	Front Housing	Rear Bearing	Circlip	Liner Sleeve	Base Plate	O Ring			
	220248	050249	130013	020984	220058	RM1650-30V			

		MAJORSELL PARTS FOR: 912 116 000 0				MAJORSELL REBUILD: 67A127R			
		Users	MAN						
		OE	51541007071						
Bore	Drive	Cooling	Weight	Mount	Lube	Water Port	Air Inlet	Air Delivery	
85 mm	Through	Water	14.5 kg	Flange	Engine Oil	M14	M26	M26	
Repair Kits	Full Kit	Head Kit	Gasket Kit	Valve Kit	Valve Plate	Cooling Plate			
	A67RK063	A67RK063A	A67RK063B	A67RK063C	A67RK063V				
Piston	Std	0.25 mm	0.50 mm	0.75 mm	1.00 mm				
	020023	020179	020024	020189	020025				
Rings	A69RK028	A69RK069	A69RK054	A69RK070	A69RK055				
Head	220287	220286 (Comp)			Rear end Cover		Conn Rod	220593	
Crankshaft	220490	140348 (Nut)			Front end Cover				
Bolts	140385 (6)	140143 (4)	140199 (6)	140316 (6)	140215 (2)				
Other Parts	Rear Bush	Base Plate	Liner Sleeve	O Ring	O Ring	Bush	Drive Gear	O Ring	
	050197	220058	020984	RM0100-30S	RM0845-30V	220491	220492	RM0840-30V	

WABCO SERIES

		MAJORSELL PARTS FOR: 912 117 000 0				MAJORSELL REBUILD: 67A128R			
		Users	MAN						
		OE	51541007070						
Bore	Drive	Cooling	Weight	Mount	Lube	Water Port	Air Inlet	Air Delivery	
85 mm	Through	Water	12 kg	Flange	Engine Oil	M14	M26	M26	
Repair Kits	Full Kit	Head Kit	Gasket Kit	Valve Kit	Valve Plate	Cooling Plate			
	A67RK063	A67RK063A	A67RK063B	A67RK063C	A67RK063V				
Piston	Std	0.25 mm	0.50 mm	0.75 mm	1.00 mm				
	020023	020179	020024	020189	020025				
Rings	A69RK028	A69RK069	A69RK054	A69RK070	A69RK055				
Head	220287	220286 (Comp)			Rear end Cover		Conn Rod	220150	
Crankshaft	220782	140348 (Nut)			Front end Cover	220622			
Bolts	140143 (4)	140385 (6)	140199 (6)	140316 (6)	140215 (2)				
Other Parts	F Flange Bush	Rear Bush	Base Plate	Liner Sleeve	O Ring	O Ring	O Ring	Drive Gear	
	220491	050197	220058	020984	RM0840-30V	RM0100-30S	RM0845-30V	220492	

		MAJORSELL PARTS FOR: 912 210 000 0				MAJORSELL REBUILD: 67A324R			
		Users							
		OE							
Bore	Drive	Cooling	Weight	Mount	Lube	Water Port	Air Inlet	Air Delivery	
100 mm		Water		Flange	Engine	M16	Tubular		
Repair Kits	Full Kit	Head Kit	Gasket Kit	Valve Kit	Valve Plate	Cooling Plate	Plastic Inlet		
	A67RK119	A67RK119A			A67RK119V	A67RK119CP	190041		
Piston	Std	0.25 mm	0.50 mm	0.75 mm	1.00 mm				
	020255	020256	020257						
Rings	A67RK120	A67RK121	A67RK122						
Head	220876	220875 (Comp)			Rear end Cover		Conn Rod	220877	
Crankshaft	220878	140203 (Nut)			Front end Cover				
Bolts	140381 (8)	140151							
Other Parts	Crank Adapter	Adapter Clip	Drive Gear	Front Bush	Rear Bush	Sump Plate	Oil Seal	Flange Ring	
	220881	130013	220872	220248	050311	220058	RM0085-40V	RM1250-30V	

		MAJORSELL PARTS FOR: 912 510 001 0				MAJORSELL REBUILD: 67A349R			
		Users	MERCEDES						
		OE	9061301615						
Bore	Drive	Cooling	Weight	Mount	Lube	Water Port	Air Inlet	Air Delivery	
85 mm	Through	Water	19 kg	Flange	Engine Oil	M14	Manifold	M26	
Repair Kits	Full Kit	Head Kit	Gasket Kit	Valve Kit	Ess Kit	Valve Plate	Cooling Plate		
	A67RK093	A67RK093A	A67RK093B	A67RK090C	A67RK085D	A67RK093V	A67RK093CP		
Piston	Std	0.25 mm	0.50 mm	0.75 mm	1.00 mm				
	020023	020179	020024	020189	020025				
Rings	A69RK028	A69RK069	A69RK054	A69RK070	A69RK055				
Head	220530	220529 (Comp)			Rear end Cover	220093	Conn Rod	220100 (2)	
Crankshaft	220775	140203 (Nut)			Front end Cover				
Bolts	140143 (4)	140131 (2)	140139 (2)	140138 (6)	140199 (2)	140135 (4)	140138 (4)		
Other Parts	Front Bush	Drive Gear	Base Plate	Liner Sleeve	O Ring	O Ring			
	050212	220178	220058 (2)	020985 (2)	RM1180-30V	RM0840-30V			

WABCO SERIES

		MAJORSELL PARTS FOR: 912 510 002 0				MAJORSELL REBUILD:			
		Users	MERCEDES						
		OE	4571305815						
Bore	Drive	Cooling	Weight	Mount	Lube	Water Port	Air Inlet	Air Delivery	
85 mm		Water	21 kg	Flange		M16	M30	M26	
Repair Kits	Full Kit	Head Kit	Gasket Kit	Valve Kit	Valve Plate	Cooling Plate			
	A67RK073	A67RK073A	A67RK073B	A67RK073C	A67RK073V1				
Piston	Std	0.25 mm	0.50 mm	0.75 mm	1.00 mm				
	020023	020179	020024	020189	020025				
Rings	A69RK028	A69RK069	A69RK054	A69RK070	A69RK055				
Head	220247	220364 (Comp)			Rear end Cover		Conn Rod		
Crankshaft					Front end Cover				
Bolts									
Other Parts									

		MAJORSELL PARTS FOR: 912 510 003 0				MAJORSELL REBUILD: 67A257R			
		Users							
		OE							
Bore	Drive	Cooling	Weight	Mount	Lube	Water Port	Air Inlet	Air Delivery	
85 mm	Through	Water	18.5 kg	Flange	Engine	14 mm	Flange	26 mm	
Repair Kits	Full Kit	Head Kit	Gasket Kit	Valve Kit	Valve Plate	Cooling Plate			
Piston	Std	0.25 mm	0.50 mm	0.75 mm	1.00 mm				
	020023	020179	020024	020189	020025				
Rings	A69RK028	A69RK069	A69RK054	A69RK070	A69RK055				
Head	220774	220773 (Comp)			Rear end Cover	220093	Conn Rod	220100	
Crankshaft	220775	140203 (Nut)			Front end Cover				
Bolts	140102 (4)	140131 (2)	140139 (2)	140138 (6)	140124 (4)	140138 (4)			
Other Parts	Front Bush	Sump Cover	Drive Gear	F Flange Seal					
	050212	220058 (2)	220178	RM1180-30V					

		MAJORSELL PARTS FOR: 912 510 103 0				MAJORSELL REBUILD:			
		Users	MERCEDES						
		OE	4571307015						
Bore	Drive	Cooling	Weight	Mount	Lube	Water Port	Air Inlet	Air Delivery	
85 mm	Through	Water	21 kg	Flange	Engine Oil	M16	M30	M26	
Repair Kits	Full Kit	Head Kit	Gasket Kit	Valve Kit	Ess Kit	Valve Plate	Cooling Plate		
	A67RK087	A67RK087A	A67RK087B	A67RK087C	A67RK085D	A67RK087V	A67RK087CP		
Piston	Std	0.25 mm	0.50 mm	0.75 mm	1.00 mm				
	020023	020179	020024	020189	020025				
Rings	A69RK028	A69RK069	A69RK054	A69RK070	A69RK055				
Head	220282	220281 (Comp)			Rear end Cover	220093	Conn Rod	220150 (2)	
Crankshaft	220141	140203 (Nut)			Front end Cover				
Bolts	140128 (6)	140151 (2)	140124 (4)	140138 (4)					
Other Parts	Gasket	Liner Sleeve	Front Bush	Sump Cover	O-Ring				
	010421	020984	050280	220058 (2)	RM0880-30V				

WABCO SERIES

		MAJORSELL PARTS FOR: 912 510 104 0				MAJORSELL REBUILD: 67A166R			
		Users	MERCEDES	AXOR					
		OE	OM457						
Bore	Drive	Cooling	Weight	Mount	Lube	Water Port	Air Inlet	Air Delivery	
85 mm	Through	Water	20 kg	Flange	Engine Oil	M16	M30	M26	
Repair Kits	Full Kit	Head Kit	Gasket Kit	Valve Kit	Ess Kit	Valve Plate	Cooling Plate		
	A67RK087	A67RK087A	A67RK087B	A67RK087C	A67RK085D	A67RK087V	A67RK087CP		
Piston	Std	0.25 mm	0.50 mm	0.75 mm	1.00 mm				
	020023	020179	020024	020189	020025				
Rings	A69RK028	A69RK069	A69RK054	A69RK070	A69RK055				
Head	220282	220281 (Comp)			Rear end Cover	220093	Conn Rod	220150	
Crankshaft	220141	140203 (Nut)			Front end Cover				
Bolts	140128 (6)	140151 (2)	140124 (4)	140138 (4)	140124 (4)	140138 (4)			
Other Parts	Front Bush	Drive Gear	Base Plate	Gasket	Front Flange Seal	O Ring	Gasket	Gasket	
	050280	220180	220058 (2)	010421	160116	RM0840-30V (2)	010407	010408	
	Liner Sleeve								
	020984								

		MAJORSELL PARTS FOR: 912 510 105 0				MAJORSELL REBUILD:			
		Users	MERCEDES						
		OE	4571305515						
Bore	Drive	Cooling	Weight	Mount	Lube	Water Port	Air Inlet	Air Delivery	
85 mm		Water	21 kg	Flange		M16	M30	M26	
Repair Kits	Full Kit	Head Kit	Gasket Kit	Valve Kit	Valve Plate	Cooling Plate			
	A67RK073	A67RK073A	A67RK073B	A67RK073C	A67RK073V1				
Piston	Std	0.25 mm	0.50 mm	0.75 mm	1.00 mm				
	020023	020179	020024	020189	020025				
Rings	A69RK028	A69RK069	A69RK054	A69RK070	A69RK055				
Head	220282	220281 (Comp)			Rear end Cover		Conn Rod		
Crankshaft					Front end Cover				
Bolts									
Other Parts	Liner Sleeve								
	020984								

		MAJORSELL PARTS FOR: 912 510 106 0				MAJORSELL REBUILD:			
		Users	MERCEDES						
		OE	4761300215						
Bore	Drive	Cooling	Weight	Mount	Lube	Water Port	Air Inlet	Air Delivery	
85 mm		Water	21 kg	Flange		M16	M30	M26	
Repair Kits	Full Kit	Head Kit	Gasket Kit	Valve Kit	Valve Plate	Cooling Plate			
	A67RK073	A67RK073A	A67RK073B	A67RK073C	A67RK073V1				
Piston	Std	0.25 mm	0.50 mm	0.75 mm	1.00 mm				
	020023	020179	020024	020189	020025				
Rings	A69RK028	A69RK069	A69RK054	A69RK070	A69RK055				
Head					Rear end Cover		Conn Rod		
Crankshaft					Front end Cover				
Bolts									
Other Parts									

WABCO SERIES

		MAJORSELL PARTS FOR: 912 510 200 0				MAJORSELL REBUILD: 67A184R		
		Users	MERCEDES					
		OE	4571306915					
Bore	Drive	Cooling	Weight	Mount	Lube	Water Port	Air Inlet	Air Delivery
95 mm	Through	Water	20 kg	Flange	Engine Oil	M16	M30	M26
Repair Kits	Full Kit	Head Kit	Gasket Kit	Valve Kit	Valve Plate	Cooling Plate		
	A67RK087	A67RK087A	A67RK087B	A67RK087C	A67RK087V1	A67RK087CP		
Piston	Std	0.25 mm	0.50 mm	0.75 mm	1.00 mm			
	020023	020179	020024	020189	020025			
Rings	A69RK028	A69RK069	A69RK054	A69RK070	A69RK055			
Head	220282	220201 (Comp)			Rear end Cover	220093	Conn Rod	220150 (2)
Crankshaft	220141	140203 (Nut)			Front end Cover			
Bolts	140143 (6)	140151 (2)	140124 (4)	140387 (2)				
Other Parts	Drive Gear	Front Bush	F End Gasket	R Cov Seal	Base Plate	Liner Sleeve	F Flange Gasket	
	220180	050280	010421	RM0880-30V	220058 (2)	020984	010421	

		MAJORSELL PARTS FOR: 912 510 201 0				MAJORSELL REBUILD: 67A183R		
		Users	MERCEDES					
		OE	4571307215					
Bore	Drive	Cooling	Weight	Mount	Lube	Water Port	Air Inlet	Air Delivery
95 mm	Through	Water	20 kg	Flange	Engine	M16	M30	M26
Repair Kits	Full Kit	Head Kit	Gasket Kit	Valve Kit	Valve Plate	Cooling Plate		
	A67RK087	A67RK087A	A67RK087B	A67RK087C	A67RK087V1	A67RK087CP		
Piston	Std	0.25 mm	0.50 mm	0.75 mm	1.00 mm			
	020023	020179	020024	020189	020025			
Rings	A69RK028	A69RK069	A69RK054	A69RK070	A69RK055			
Head	220282	220201 (Comp)			Rear end Cover	220093	Conn Rod	220150 (2)
Crankshaft	220141	140203 (Nut)			Front end Cover			
Bolts	140143 (6)	140151 (2)	140199 (2)	140138 (6)	140124 (4)	140138 (4)		
Other Parts	Front Bush	End Gasket	R Cover Seal	Sump Cover	Liner Sleeve	Drive Gear		
	050280	010421	RM0880-30V	220058 (2)	020984	220180		

		MAJORSELL PARTS FOR: 912 510 300 0				MAJORSELL REBUILD: 67A312R		
		Users						
		OE						
Bore	Drive	Cooling	Weight	Mount	Lube	Water Port	Air Inlet	Air Delivery
85 mm	Through							
Repair Kits	Full Kit	Head Kit	Gasket Kit	Valve Kit	Ess Kit	Valve Plate	Valve Plate	Cooling Plate
	A67RK094	A67RK094A	A67RK094B	A67RK094C	A67RK085D	A67RK094V	A67RK094V1	A67RK094CP
Piston	Std	0.25 mm	0.50 mm	0.75 mm	1.00 mm			
	020023	020179	020024	020189	020025			
Rings	A69RK028	A69RK069	A69RK054	A69RK070	A69RK055			
Head	220532	220531 (Comp)	220534	220533 (Comp)	Rear end Cover	220187	Conn Rod	220150 (2)
Crankshaft		140203 (Nut)			Front end Cover	220248		
Bolts	140128 (9)	140151 (1)	140210 (2)	140385 (8)	140132 (1)			
Other Parts	Front Bearing	Front Bush	Rear Bush	Housing Clip	Rear Seal	Base Plate	Seal	Seal
	6015	050280	050249	130013	RM180-30V	220058 (3)	RM1056-24 (2)	RM0246-24 (2)
	Drive Gear	Seal	Seal	O Ring				
	220180	160116	RM0840-30V (2)	RM1180-30V				

WABCO SERIES

		MAJORSELL PARTS FOR: 912 512 001 0				MAJORSELL REBUILD: 67A106R		
		Users	VOLVO					
		OE	20477943	20569251				
Bore	Drive	Cooling	Weight	Mount	Lube	Water Port	Air Inlet	Air Delivery
85 mm	Non-Through	Water	22 kg	Flange	Engine Oil	M16	Manifold	M26
Repair Kits	Full Kit	Head Kit	Gasket Kit	Valve Kit	Ess Kit	Valve Plate	Cooling Plate	
	A67RK088	A67RK088A	A67RK088B	A67RK085C	A67RK085D	A67RK085V	A67RK085CP	
Piston	Std	0.25 mm	0.50 mm	0.75 mm	1.00 mm			
	020023	020179	020024	020189	020025			
Rings	A69RK028	A69RK069	A69RK054	A69RK070	A69RK055			
Head	220333	220332 (Comp)			Rear end Cover	220187	Conn Rod	220100 (2)
Crankshaft		140016 (Nut)			Front end Cover			
Bolts	140143 (6)	140384 (2)						
Other Parts	Front Bearing	Rear Bush	Base Plate	O Ring	Circlip			
	220248	050249	220058 (2)	RM1550-30V	130013			

		MAJORSELL PARTS FOR: 912 512 004 0				MAJORSELL REBUILD: 67A072R		
		Users						
		OE						
Bore	Drive	Cooling	Weight	Mount	Lube	Water Port	Air Inlet	Air Delivery
85 mm	Non-Through	Water	19 kg	Flange	Engine	M16	Manifold	M26
Repair Kits	Full Kit	Head Kit	Gasket Kit	Valve Kit	Ess Kit	Valve Plate	Cooling Plate	
	A67RK085	A67RK085A	A67RK085B	A67RK085C	A67RK085D	A67RK085V	A67RK085CP	
Piston	Std	0.25 mm	0.50 mm	0.75 mm	1.00 mm			
	020023	020179	020024	020189	020025			
Rings	A69RK028	A69RK069	A69RK054	A69RK070	A69RK055			
Head	220331	220299 (Comp)			Rear end Cover	220187	Conn Rod	220100 (2)
Crankshaft	220699	140016 (Nut)			Front end Cover			
Bolts	140143 (6)	140275 (2)	140138 (6)	140276 (2)				
Other Parts	Front Housing	Rear Bush	Sump Cover	Front Curclip	F Flange Seal			
	220248	220249	220058 (2)	130013	RM1250-30V			

* Superseded by 912 512 008 0

		MAJORSELL PARTS FOR: 912 512 006 0				MAJORSELL REBUILD: 67A229R		
		Users	VOLVO					
		OE	20770303					
Bore	Drive	Cooling	Weight	Mount	Lube	Water Port	Air Inlet	Air Delivery
85 mm	Non-Through	Water	19 kg	Flange	Engine Oil	M16	Manifold	M26
Repair Kits	Full Kit	Head Kit	Gasket Kit	Valve Kit	Ess Kit	Valve Plate	Cooling Plate	
	A67RK085	A67RK085A	A67RK085B	A67RK085C	A67RK085D	A67RK085V	A67RK085CP	
Piston	Std	0.25 mm	0.50 mm	0.75 mm	1.00 mm			
	020023	020179	020024	020189	020025			
Rings	A69RK028	A69RK069	A69RK054	A69RK070	A69RK055			
Head	220331	220299 (Comp)			Rear end Cover	220187	Conn Rod	220100 (2)
Crankshaft	220068	140016 (Nut)			Front end Cover			
Bolts	140143 (6)	140275 (2)	140138 (6)	140276 (2)				
Other Parts	Front Bearing	Rear Bush	Base Plate	O Ring	Circlip	Liner Sleeve		
	220248	050249	220058 (2)	RM1250-30V	130013	020986		

WABCO SERIES

		MAJORSELL PARTS FOR: 912 512 029 0				MAJORSELL REBUILD: 67A264R		
		Users						
		OE						
Bore	Drive	Cooling	Weight	Mount	Lube	Water Port	Air Inlet	Air Delivery
85 mm	Non-Through	Water	20.50 kg	Flange	Engine	M16	Manifold	M26
Repair Kits	Full Kit	Head Kit	Gasket Kit	Valve Kit	Valve Plate	Cooling Plate		
	A67RK108	A67RK108A	A67RK108B	A67RK108C	A67RK108V	A67RK085CP		
Piston	Std	0.25 mm	0.50 mm	0.75 mm	1.00 mm			
	020023	020179	020024	020189	020025			
Rings	A69RK028	A69RK069	A69RK054	A69RK070	A69RK055			
Head	220331	220698 (Comp)			Rear end Cover	220187	Conn Rod	220100 (2)
Crankshaft	220699	140016 (Nut)			Front end Cover			
Bolts	140143 (6)	140275 (2)	140138 (6)	140276 (2)				
Other Parts	Front Housing	Rear Bush	Sump Cover	Flange Clip	Flange Seal	Air Intake Seal		
	220248	050249	220058 (2)	130013	RM1650-30V	160126		

		MAJORSELL PARTS FOR: 912 514 001 0				MAJORSELL REBUILD: 67A118R		
		Users	RVI					
		OE	21353473					
Bore	Drive	Cooling	Weight	Mount	Lube	Water Port	Air Inlet	Air Delivery
85 mm	Through	Water	21 kg	Flange	Engine Oil	M16	Manifold	M26
Repair Kits	Full Kit	Head Kit	Gasket Kit	Valve Kit	Ess Kit	Valve Plate	Cooling Plate	
	A67RK088	A67RK088A	A67RK088B	A67RK085C	A67RK085D	A67RK085V	A67RK085CP	
Piston	Std	0.25 mm	0.50 mm	0.75 mm	1.00 mm			
	020023	020179	020024	020189	020025			
Rings	A69RK028	A69RK069	A69RK054	A69RK070	A69RK055			
Head		220299 (Comp)			Rear end Cover	220187	Conn Rod	220100 (2)
Crankshaft	220068	140016 (Nut)			Front end Cover			
Bolts	140143 (6)	140275 (2)	140276 (2)					
Other Parts	Front Bearing	Rear Bush	Base Plate	O Ring	Liner Sleeve			
	220248	050249	220058 (2)	RM1650-30V	020986			

* Superseded by 912 514 004 0

		MAJORSELL PARTS FOR: 912 514 003 0				MAJORSELL REBUILD: 67A247R		
		Users	RVI					
		OE	21353473					
Bore	Drive	Cooling	Weight	Mount	Lube	Water Port	Air Inlet	Air Delivery
85 mm	Through	Water	21 kg	Flange	Engine Oil	M16	Manifold	M26
Repair Kits	Full Kit	Head Kit	Gasket Kit	Valve Kit	Ess Kit	Valve Plate	Cooling Plate	
	A67RK088	A67RK088A	A67RK088B	A67RK085C	A67RK085D	A67RK085V	A67RK085CP	
Piston	Std	0.25 mm	0.50 mm	0.75 mm	1.00 mm			
	020023	020179	020024	020189	020025			
Rings	A69RK028	A69RK069	A69RK054	A69RK070	A69RK055			
Head	220331	220299 (Comp)			Rear end Cover		Conn Rod	
Crankshaft	220100 (2)				Front end Cover			
Bolts	140143 (6)	140210 (2)						
Other Parts	Front Bearing	Rear Bush	O Ring	Liner Sleeve	Base Plate			
	220248	050249	RM1180-30V	020986 (2)	220058 (2)			

WABCO SERIES

		MAJORSELL PARTS FOR: 912 514 004 0				MAJORSELL REBUILD: 67A119R		
		Users	RVI					
		OE	21353473	7485003297				
Bore	Drive	Cooling	Weight	Mount	Lube	Water Port	Air Inlet	Air Delivery
85 mm	Through	Water	21 kg	Flange	Engine Oil	M16	Manifold	M26
Repair Kits	Full Kit	Head Kit	Gasket Kit	Valve Kit	Ess Kit	Valve Plate	Cooling Plate	
	A67RK088	A67RK088A	A67RK088B	A67RK085C	A67RK085D	A67RK085V	A67RK085CP	
Piston	Std	0.25 mm	0.50 mm	0.75 mm	1.00 mm			
	020023	020179	020024	020189	020025			
Rings	A69RK028	A69RK069	A69RK054	A69RK070	A69RK055			
Head	220331	220299 (Comp)			Rear end Cover	220187	Conn Rod	220100 (2)
Crankshaft	220068	140016 (Nut)			Front end Cover			
Bolts	140143 (6)	140210 (2)						
Other Parts	Front Bearing	Rear Bush	Base Plate	Circlip	Liner Sleeve	O Ring		
	220248	050249	220058 (2)	130013	020986 (2)	RM1180-30V		

* Replaced by 912 514 009 0

		MAJORSELL PARTS FOR: 912 514 009 0				MAJORSELL REBUILD: 67A255R		
		Users						
		OE						
Bore	Drive	Cooling	Weight	Mount	Lube	Water Port	Air Inlet	Air Delivery
85 mm	Non-Through	Water	20.50 kg	Flange	Engine Oil	16 mm	Manifold	26 mm
Repair Kits	Full Kit	Head Kit	Gasket Kit	Valve Kit	Ess Kit	Valve Plate	Cooling Plate	
	A67RK108	A67RK108A	A67RK108B	A67RK108C	A67RK085D	A67RK0108V	A67RK108CP	
Piston	Std	0.25 mm	0.50 mm	0.75 mm	1.00 mm			
	020023	020179	020024	020189	020025			
Rings	A69RK028	A69RK069	A69RK054	A69RK070	A69RK055			
Head	220331	220698 (Comp)			Rear end Cover	220187	Conn Rod	220100 (2)
Crankshaft	220699	140016 (Nut)			Front end Cover			
Bolts	140143 (6)	140275 (2)	140276 (2)	140138 (6)				
Other Parts	Front Housing	Rear Bush	Base Plate	Front Flange Clip		Front Flange Seal		O Ring
	220248	050249	220058 (2)	130013		RM1650-30V		160126

		MAJORSELL PARTS FOR: 912 518 003 0				MAJORSELL REBUILD: 67A299R		
		Users	DAF					
		OE	1696197					
Bore	Drive	Cooling	Weight	Mount	Lube	Water Port	Air Inlet	Air Delivery
85 mm	Through	Water	27 kg	Side	Engine Oil	M16	M33	M22
Repair Kits	Full Kit	Head Kit	Gasket Kit	Valve Kit	Ess Kit	Valve Plate	Cooling Plate	
	A67RK090	A67RK090A	A67RK090B	A67RK090C	A67RK090D	A67RK090V	A67RK090CP	
Piston	Std	0.25 mm	0.50 mm	0.75 mm	1.00 mm			
	020023	020179	020024	020189	020025			
Rings	A69RK028	A69RK069	A69RK054	A69RK070	A69RK055			
Head	220340	220339 (Comp)			Rear end Cover		Conn Rod	220432
Crankshaft		140016 (Nut)			Front end Cover			220150
Bolts	140151 (6)	140199 (6)						
Other Parts	Front Bush	Rear Bearing	Base Plate	O Ring	Bearing Flange			
	050249	6308	220058 (2)	RM1360-60	220433			

WABCO SERIES

		MAJORSELL PARTS FOR: 912 518 005 0				MAJORSELL REBUILD: 67A302R			
		Users							
		OE							
Bore	Drive	Cooling	Weight	Mount	Lube	Water Port	Air Inlet	Air Delivery	
85mm	Through	Water	27kg	Side	Engine	16mm	33mm	22mm	
Repair Kits	Full Kit	Head Kit	Gasket Kit	Valve Kit	Ess Kit	Valve Plate	Cooling Plate		
	A67RK090	A67RK090A	A67RK090B	A67RK090C	A67RK090D	A67RK090V1	A67RK090CP		
Piston	Std	0.25 mm	0.50 mm	0.75 mm	1.00 mm				
	020023	020179	020024	020189	020025				
Rings	A69RK028	A69RK069	A69RK054	A69RK070	A69RK055				
Head	220940	220939 (Comp)			Rear end Cover		Conn Rod	220434	
Crankshaft	220432	140016 (Nut)			Front end Cover			220150	
Bolts	140151 (6)	140341 (6)	140199 (6)						
Other Parts	Front Bush	Rear Bearing	Base Plate	O Ring	Bearing Flange		Rear Clip	Drive Gear	
	050249	6308	220058 (2)	RM1360-60	220433		130013	220704	

		MAJORSELL PARTS FOR: 912 518 107 0				MAJORSELL REBUILD: 67A311R			
		Users							
		OE							
Bore	Drive	Cooling	Weight	Mount	Lube	Water Port	Air Inlet	Air Delivery	
85 mm	Through	Water	27 kg	side	Engine	16 mm	30 mm	26 mm	
Repair Kits	Full Kit	Head Kit	Gasket Kit	Valve Kit	Ess Kit	Valve Plate	Cooling Plate		
	A67RK087	A67RK087A	A67RK087B	A67RK087C	A67RK085D	A67RK087V	A67RK087CP		
Piston	Std	0.25 mm	0.50 mm	0.75 mm	1.00 mm				
	020023	020179	020024	020189	020025				
Rings	A69RK028	A69RK069	A69RK054	A69RK070	A69RK055				
Head	220353	220352 (Comp)			Rear end Cover		Conn Rod	220150	
Crankshaft	220862	140016 (Nut)			Front end Cover				
Bolts	140128 (6)	140151 (2)	140138 (6)						
Other Parts	Front Bush	Clip	Rear Bearing	Sump Cover	Drive Gear	Flange Seal			
	050249	130013	6803-C3	220058 (2)	220730	RM1360-60			

		MAJORSELL PARTS FOR: 912 518 200 0				MAJORSELL REBUILD: 67A232R			
		Users		DAF					
		OE		1689065	1795776	1736790			
Bore	Drive	Cooling	Weight	Mount	Lube	Water Port	Air Inlet	Air Delivery	
85 mm	Non-Through	Water	18 kg	Flange	Engine Oil	M16	M30	M26	
Repair Kits	Full Kit	Head Kit	Gasket Kit	Valve Kit	Ess Kit	Valve Plate	Cooling Plate		
	A67RK087	A67RK087A	A67RK087B	A67RK087C	A67RK085D	A67RK087V	A67RK087CP		
Piston	Std	0.25 mm	0.50 mm	0.75 mm	1.00 mm				
	020023	020179	020024	020189	020025				
Rings	A69RK028	A69RK069	A69RK054	A69RK070	A69RK055				
Head	220353	220352 (Comp)			Rear end Cover	220187	Conn Rod	220150 (2)	
Crankshaft		140330 (Pin)			Front end Cover				
Bolts	140128 (6)	140151 (2)	140138 (6)	140199 (2)	140184 (1)	140098 (1)			
Other Parts	Front Bush	Rear Bush	Base Plate	O Ring	Liner Sleeve	Circlip			
	220248	050249	220058 (2)	RM1250-35V	020986 (2)	130013			

* Replaced by 912 518 204 0

WABCO SERIES





		MAJORSELL PARTS FOR: 912 518 202 0				MAJORSELL REBUILD: 67A152R		
		Users	DAF					
		OE	1736790					
Bore	Drive	Cooling	Weight	Mount	Lube	Water Port	Air Inlet	Air Delivery
85 mm	Non-Through	Water	18 kg	Flange	Engine Oil	M16	M30	M26
Repair Kits	Full Kit	Head Kit	Gasket Kit	Valve Kit	Ess Kit	Valve Plate	Cooling Plate	
	A67RK087	A67RK087A	A67RK087B	A67RK087C	A67RK085D	A67RK087V	A67RK087CP	
Piston	Std	0.25 mm	0.50 mm	0.75 mm	1.00 mm			
	020023	020179	020024	020189	020025			
Rings	A69RK028	A69RK069	A69RK054	A69RK070	A69RK055			
Head	220353	220352 (Comp)			Rear end Cover	220187	Conn Rod	220150 (2)
Crankshaft		140330 (Pin)			Front end Cover			
Bolts	140128 (6)	140210 (2)	140138 (6)	140199 (2)	140098 (1)	140184 (1)		
Other Parts	Front Bush	Rear Bush	Base Plate	O Ring	Liner Sleeve	Clip		
	220248	050249	220058 (2)	RM1250-35V	020986	130013		

		MAJORSELL PARTS FOR: 912 518 206 0				MAJORSELL REBUILD: 67A120R		
		Users	DAF					
		OE	1813541					
Bore	Drive	Cooling	Weight	Mount	Lube	Water Port	Air Inlet	Air Delivery
85 mm	Non-Through	Water	18 kg	Flange	Engine Oil	M16	M30	M26
Repair Kits	Full Kit	Head Kit	Gasket Kit	Valve Kit	Ess Kit	Valve Kit	Cooling Plate	
	A67RK087	A67RK087A	A67RK087B	A67RK087C	A67RK085D	A67RK087V	A67RK087CP	
Piston	Std	0.25 mm	0.50 mm	0.75 mm	1.00 mm			
	020023	020179	020024	020189	020025			
Rings	A69RK028	A69RK069	A69RK054	A69RK070	A69RK055			
Head	220353	220352 (Comp)			Rear end Cover	220187	Conn Rod	220150 (2)
Crankshaft	220595	140331 (Pin)			Front end Cover			
Bolts	140128 (6)	140210(2)	140138 (6)	140199 (2)	140334	140335		
Other Parts	Base Plate	O Ring	Front Bush	Rear Bush	Liner Sleeve	Clip		
	220058 (2)	RM1250-35V	220248	050249	020986	130013		

		MAJORSELL PARTS FOR: 912 518 207 0				MAJORSELL REBUILD: 67A121R		
		Users	DAF					
		OE	1813542					
Bore	Drive	Cooling	Weight	Mount	Lube	Water Port	Air Inlet	Air Delivery
85 mm	Non-Through	Water	18 kg	Flange	Engine Oil	M16	M30	M26
Repair Kits	Full Kit	Head Kit	Gasket Kit	Valve Kit	Valve Plate	Valve Plate	Cooling Plate	
	A67RK087	A67RK087A	A67RK087B	A67RK087C	A67RK085D	A67RK087V	A67RK087CP	
Piston	Std	0.25 mm	0.50 mm	0.75 mm	1.00 mm			
	020023	020179	020024	020189	020025			
Rings	A69RK028	A69RK069	A69RK054	A69RK070	A69RK055			
Head	220353	220352 (Comp)			Rear end Cover	220187	Conn Rod	220100 (2)
Crankshaft	220787	140331 (Pin)			Front end Cover			
Bolts	140128 (6)	140210 (2)	140138 (6)	140199 (2)	140334	140335		
Other Parts	Front Bush	Rear Bush	Base Plate	O Ring	Liner Sleeve	Circlip		
	220248	050249	220058 (2)	RM1250-35V	020986 (2)	130013		

REPAIR KITS

A67RK001

		
Full Kit: A67RK001	Head Kit: A67RK001A	Gasket Kit: A67RK001B
		
Valve Kit: A67RK001C		Valve Plate: A67RK001V

A67RK004





		
Full Kit: A67RK004	Head Kit: A67RK004A	Gasket Kit: A67RK004B
		
Valve Kit: A67RK004C		Valve Plate: A67RK004V

A67RK005



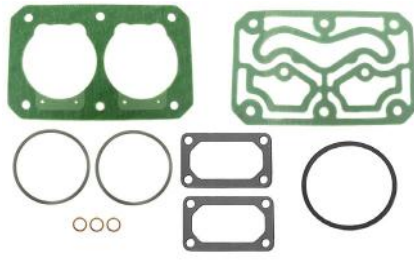

		
Full Kit: A67RK005	Head Kit: A67RK005A	Gasket Kit: A67RK005B
		
Valve Kit: A67RK005C		

REPAIR KITS

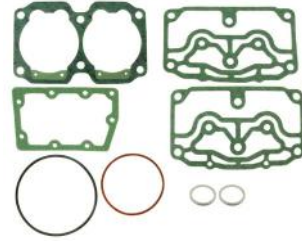

A67RK017

		
Full Kit: A67RK017	Head Kit: A67RK017A	Gasket Kit: A67RK017B
		
Valve Kit: A67RK017C		

A67RK019

		
Full Kit: A67RK019	Head Kit: A67RK019A	Gasket Kit: A67RK019B
		
Valve Kit: A67RK019C		Valve Plate: A67RK019V

A67RK021

<p style="font-size: 24px; font-weight: bold; color: red;">IN DEVELOPMENT</p>		
	Head Kit: A67RK021A	
		
Valve Kit: A67RK021C		

REPAIR KITS

A67RK024

		
Full Kit: A67RK024	Head Kit: A67RK024A	Gasket Kit: A67RK024B
		
Valve Kit: A67RK024C		Valve Plate: A67RK024V

A67RK025





		
Full Kit: A67RK025	Head Kit: A67RK025A	Gasket Kit: A67RK025B
		
Valve Kit: A67RK025C		Valve Plate: A67RK025V

A67RK026

		
Full Kit: A67RK026	Head Kit: A67RK026A	Gasket Kit: A67RK026B
		
Valve Kit: A67RK026C		Valve Plate: A67RK026V

REPAIR KITS

A67RK035

		
Full Kit: A67RK035	Head Kit: A67RK035A	Gasket Kit: A67RK035B
		
Valve Kit: A67RK035C		Valve Plate: A67RK035V

A67RK036

		
Full Kit: A67RK036	Head Kit: A67RK036A	Gasket Kit: A67RK036B
		
		Valve Plate: A67RK036V

A67RK037

		
Full Kit: A67RK037	Head Kit: A67RK037A	Gasket Kit: A67RK037B
		
		Valve Plate: A67RK037V

REPAIR KITS

A67RK038

		
Full Kit: A67RK038	Head Kit: A67RK038A	Gasket Kit: A67RK038B
		
Valve Kit: A67RK038C		

A67RK047

		
Full Kit: A67RK047	Head Kit: A67RK047A	Gasket Kit: A67RK047B
		
Valve Kit: A67RK047C		

A67RK049

		
Full Kit: A67RK049	Head Kit: A67RK049A	Gasket Kit: A67RK049B

REPAIR KITS

A67RK050

			
Full Kit: A67RK050	Head Kit: A67RK050A	Gasket Kit: A67RK050B	
			
Valve Kit: A67RK050C			Mounting Kit: A67RK050F

A67RK053

			
Full Kit: A67RK053	Head Kit: A67RK053A	Gasket Kit: A67RK053B	

A67RK054

			
Full Kit: A67RK054	Head Kit: A67RK054A	Gasket Kit: A67RK054B	
			
Valve Kit: A67RK054C	Ess Kit: A67RK054D	Cooling Plate: A67RK054CP	Valve Plate: A67RK054V

REPAIR KITS

A67RK055

		
Full Kit: A67RK055	Head Kit: A67RK055A	Gasket Kit: A67RK055B
		
Valve Kit: A67RK055C		Valve Plate: A67RK055V

A67RK056







		
Full Kit: A67RK056	Head Kit: A67RK056A	Gasket Kit: A67RK056B
		
Valve Kit: A67RK056C		Valve Plate: A67RK056V

A67RK057



		
Full Kit: A67RK057	Head Kit: A67RK057A	Gasket Kit: A67RK057B
		
Valve Kit: A67RK057C		Valve Plate: A67RK057V

REPAIR KITS







A67RK058

			
Full Kit: A67RK058	Head Kit: A67RK058A	Gasket Kit: A67RK058B	
			
Valve Kit: A67RK058C	Ess Kit: A67RK058D	Ess Kit: A67RK058D1	Valve Plate: A67RK058V

A67RK059

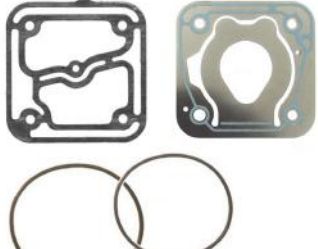
			
Full Kit: A67RK059	Head Kit: A67RK059A	Gasket Kit: A67RK059B	
			
Valve Kit: A67RK059C	Ess Kit:	Ess Kit:	Valve Plate: A67RK059V

A67RK060



			
Full Kit: A67RK060	Head Kit: A67RK060A	Gasket Kit: A67RK060B	
			
Valve Kit: A67RK060C	Ess Kit:	Ess Kit:	Valve Plate: A67RK060V

REPAIR KITS



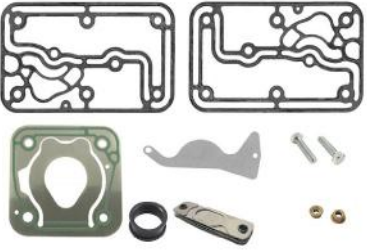

A67RK061

			
Full Kit: A67RK061	Head Kit: A67RK061A	Gasket Kit: A67RK061B	
			
Valve Kit: A67RK061C		Cooling Plate: A67RK061CP	Valve Plate: A67RK061V

A67RK062

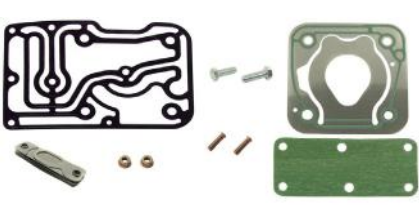
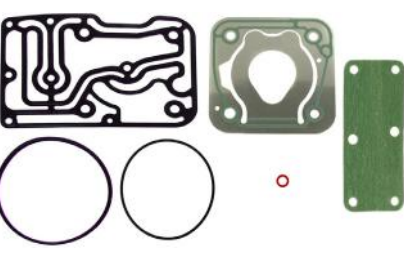

			
Full Kit: A67RK062	Head Kit: A67RK062A	Gasket Kit: A67RK062B	
			
Valve Kit: A67RK062C	Ess Kit: A67RK062D	Cooling Plate: A67RK062CP	Valve Plate: A67RK062V

A67RK063



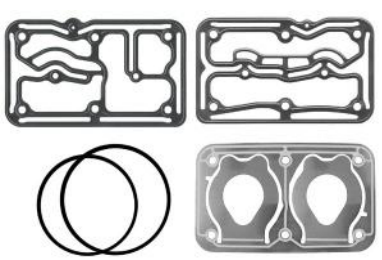

			
Full Kit: A67RK063	Head Kit: A67RK063A	Gasket Kit: A67RK063B	
			
Valve Kit: A67RK063C		Valve Plate: A67RK063V	Valve Plate: A67RK063V1

REPAIR KITS



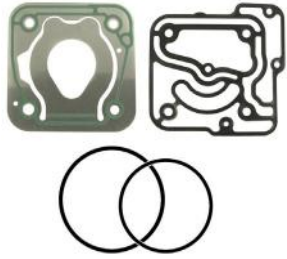

A67RK065

 <p>Full Kit: A67RK065</p>	 <p>Head Kit: A67RK065A</p>	 <p>Gasket Kit: A67RK065B</p>	
 <p>Valve Kit: A67RK065C</p>	 <p>Cooling Plate: A67RK065CP</p>	 <p>Valve Plate: A67RK065V</p>	 <p>Valve Plate: A67RK065V1</p>

A67RK066

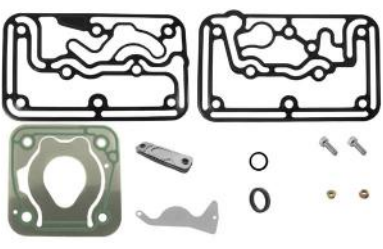
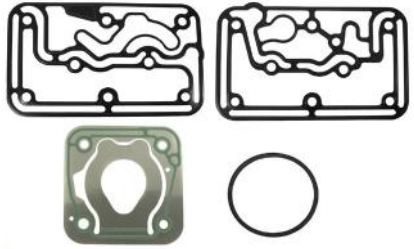



 <p>Full Kit: A67RK066</p>	 <p>Head Kit: A67RK066A</p>	 <p>Gasket Kit: A67RK066B</p>	
 <p>Valve Kit: A67RK066C</p>	 <p>A67RK066FP</p>	 <p>Valve Plate: A67RK066V</p>	

A67RK067

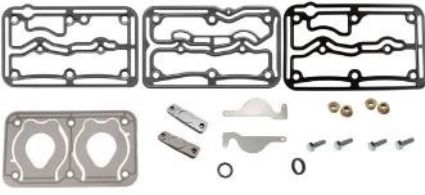
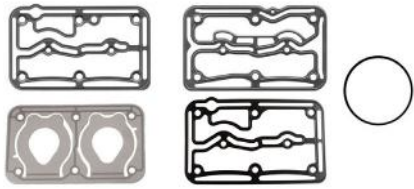

 <p>Full Kit: A67RK067</p>	 <p>Head Kit: A67RK067A</p>	 <p>Gasket Kit: A67RK067B</p>	
 <p>Valve Kit: A67RK067C</p>	 <p>Cooling Plate: A67RK067CP</p>	 <p>Valve Plate: A67RK067V</p>	

REPAIR KITS







A67RK068

 <p>Full Kit: A67RK068</p>	 <p>Head Kit: A67RK068A</p>	 <p>Gasket Kit: A67RK068B</p>	
 <p>Valve Kit: A67RK068C</p>	 <p>Cooling Plate: A67RK068CP</p>	 <p>Valve Plate: A67RK068V</p>	 <p>Valve Plate: A67RK068V1</p>

A67RK069

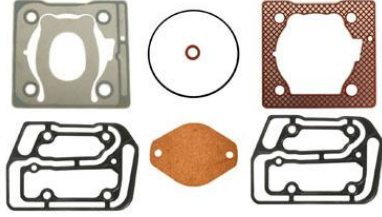

 <p>Full Kit: A67RK069</p>	 <p>Head Kit: A67RK069A</p>	 <p>Gasket Kit: A67RK069B</p>	
 <p>Valve Kit: A67RK069C</p>	 <p>Valve Plate: A67RK069V</p>	<p style="font-size: 1.2em; font-weight: bold; color: red;">IN DEVELOPMENT</p>	
		 <p>Valve Plate: A67RK069V1</p>	

A67RK070









 <p>Full Kit: A67RK070</p>	 <p>Head Kit: A67RK070A</p>	 <p>Gasket Kit: A67RK070B</p>	
 <p>Valve Kit: A67RK070C</p>	 <p>Cooling Plate: A67RK070CP</p>	 <p>Valve Plate: A67RK070V</p>	

REPAIR KITS

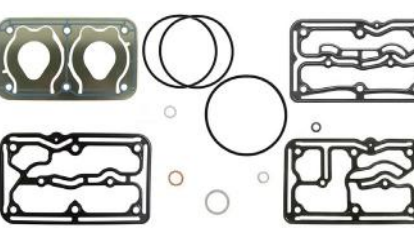
A67RK072



			
Full Kit: A67RK072	Head Kit: A67RK072A	Gasket Kit: A67RK072B	
			
Valve Kit: A67RK072C			Valve Plate: A67RK072V

A67RK073







			
Full Kit: A67RK073	Head Kit: A67RK073A	Gasket Kit: A67RK073B	
			
Valve Kit: A67RK073C	Ess Kit: A67RK073D	Cooling Plate: A67RK073CP	Valve Plate: A67RK073V
			
Valve Plate: A67RK072V1			

REPAIR KITS

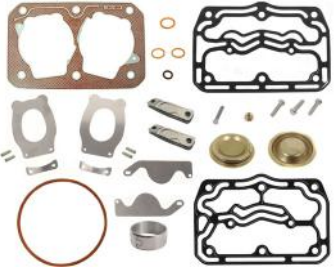

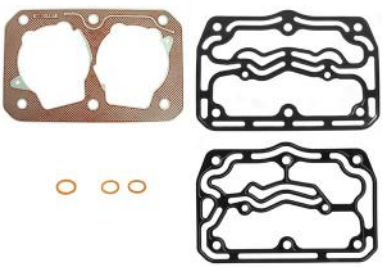

A67RK074

			
Full Kit: A67RK074	Head Kit: A67RK074A	Gasket Kit: A67RK074B	
			
Valve Kit: A67RK074C		Ess Kit: A67RK074CP	Valve Plate: A67RK074V

A67RK082



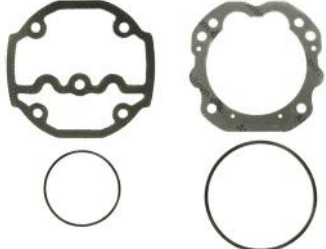

			
Full Kit: A67RK082	Head Kit: A67RK082A	Gasket Kit: A67RK082B	
			
Valve Kit: A67RK082C	Ess Kit: A67RK082D	Cooling Plate: A67RK082CP	Valve Plate: A67RK082V

A67RK083



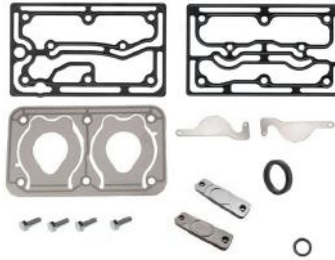
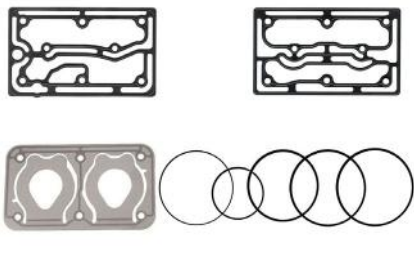

			
Full Kit: A67RK083	Head Kit: A67RK083A	Gasket Kit: A67RK083B	
			
Valve Kit: A67RK083C			

REPAIR KITS



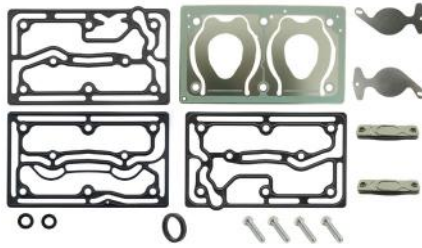
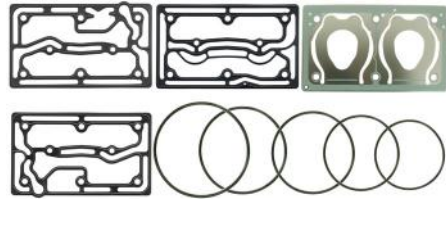

A67RK084

			
Full Kit: A67RK084	Head Kit: A67RK084A	Gasket Kit: A67RK084B	
			
	A67RK084FP	Cooling Plate: A67RK084CP	Valve Plate: A67RK084V

A67RK085

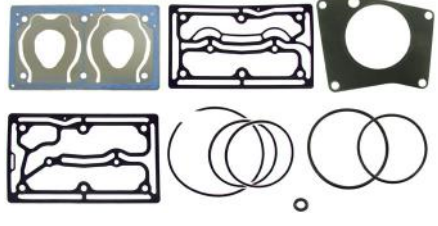

			
Full Kit: A67RK085	Head Kit: A67RK085A	Gasket Kit: A67RK085B	
			
Valve Kit: A67RK085C	Ess Kit: A67RK085D	Cooling Plate: A67RK085CP	Valve Plate: A67RK085V

A67RK087

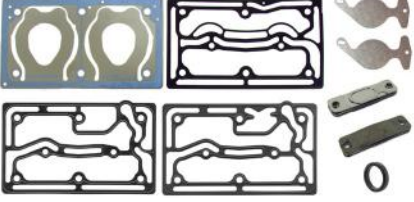
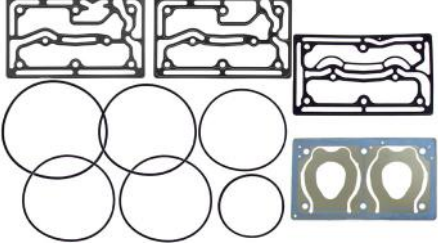

			
Full Kit: A67RK087	Head Kit: A67RK087A	Gasket Kit: A67RK087B	
			
Valve Kit: A67RK087C		Cooling Plate: A67RK087CP	Valve Plate: A67RK087V

REPAIR KITS





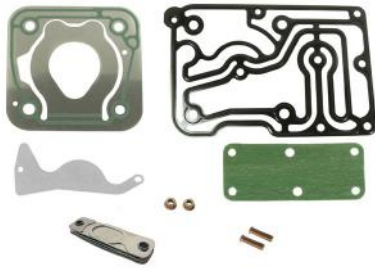
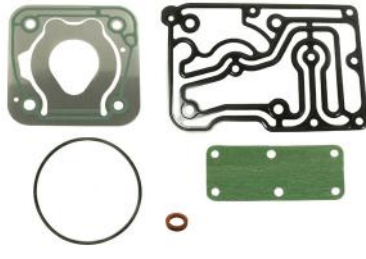

A67RK088

 <p>Full Kit: A67RK088</p>	 <p>Head Kit: A67RK088A</p>	 <p>Gasket Kit: A67RK088B</p>
 <p>Valve Plate: A67RK088V</p>		

A67RK089

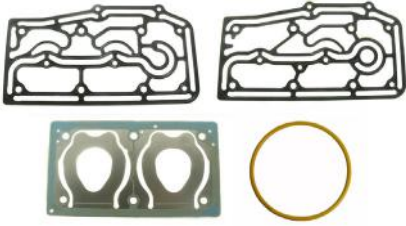
 <p>Full Kit: A67RK089</p>	 <p>Head Kit: A67RK089A</p>	 <p>Gasket Kit: A67RK089B</p>	
 <p>Valve Kit: A67RK089C</p>			

A67RK090







 <p>Full Kit: A67RK090</p>	 <p>Head Kit: A67RK090A</p>	 <p>Gasket Kit: A67RK090B</p>
 <p>Valve Kit: A67RK090C</p>	 <p>Cooling Plate: A67RK090CP</p>	 <p>Valve Plate: A67RK090V</p>

REPAIR KITS

A67RK091

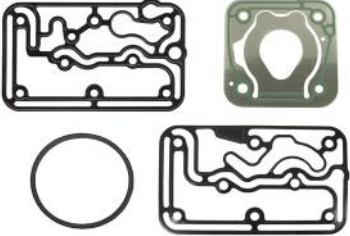
			
Full Kit: A67RK091	Head Kit: A67RK091A	Gasket Kit: A67RK091B	
			
Valve Kit: A67RK091C	Ess Kit: A67RK091D1	Cooling Plate: A67RK091CP	Valve Plate: A67RK091V

A67RK092

		
Full Kit: A67RK092	Head Kit: A67RK092A	Gasket Kit: A67RK092B
		
Valve Kit: A67RK092C	Cooling Plate: A67RK092CP	Valve Plate: A67RK092V

A67RK093

		
Full Kit: A67RK093	Head Kit: A67RK093A	Gasket Kit: A67RK093B
		
Ess Kit: A67RK093CP	Valve Plate: A67RK093V	

REPAIR KITS

A67RK095

 <p>Full Kit: A67RK095</p>	 <p>Head Kit: A67RK095A</p>	 <p>Gasket Kit: A67RK095B</p>
 <p>Valve Kit: A67RK095C</p>		 <p>Valve Plate: A67RK095V</p>

A67RK096

 <p>Full Kit: A67RK096</p>	 <p>Head Kit: A67RK096A</p>	 <p>Gasket Kit: A67RK096B</p>
 <p>Valve Kit: A67RK096C</p>	 <p>Ess Kit: A67RK096D</p>	 <p>Valve Plate: A67RK096V</p>

A67RK097



 <p>Full Kit: A67RK097</p>	 <p>Head Kit: A67RK097A</p>	 <p>Gasket Kit: A67RK097B</p>
 <p>Valve Kit: A67RK097C</p>	 <p>Cooling Plate: A67RK097CP</p>	 <p>Valve Plate: A67RK097V</p>

REPAIR KITS

A67RK098 & A67RK109

 <p>Full Kit: A67RK098</p>	 <p>Head Kit: A67RK098A</p>	 <p>Gasket Kit: A67RK098B</p>	
 <p>Valve Kit: A67RK098C</p>	 <p>Valve Plate: A67RK098V</p>		 <p>Valve Plate: A67RK109V1</p>

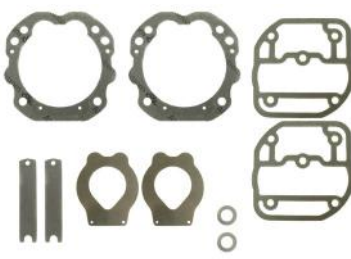
A67RK112





 <p>Full Kit: A67RK112</p>	 <p>Head Kit: A67RK112A</p>	 <p>Gasket Kit: A67RK112B</p>	
 <p>Valve Kit: A67RK112C</p>			

A67RK113

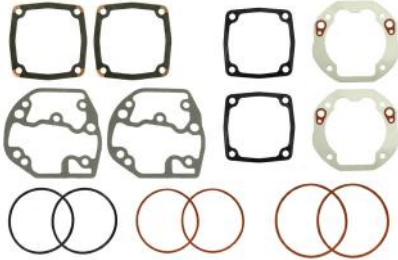

 <p>Full Kit: A67RK113</p>	 <p>Head Kit: A67RK113A</p>	 <p>Gasket Kit: A67RK113B</p>	
 <p>Valve Kit: A67RK113C</p>			

REPAIR KITS

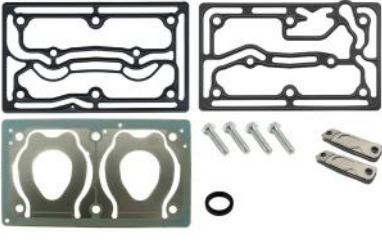
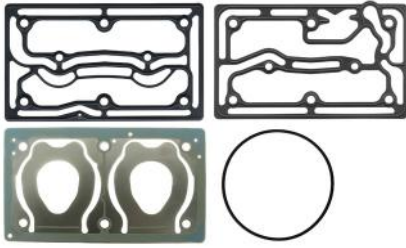

A67RK114

			
Full Kit: A67RK114	Head Kit: A67RK114A	Gasket Kit: A67RK114B	
			
Valve Kit: A67RK114C			

A67RK115

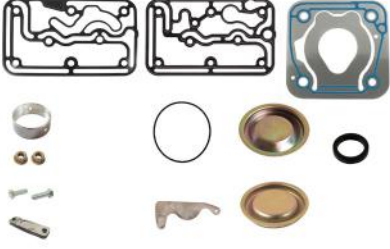
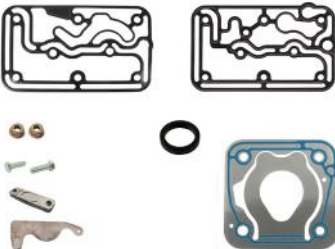
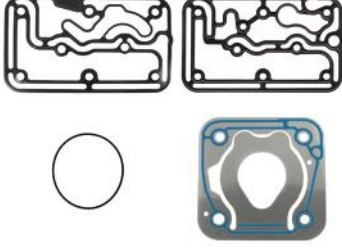

			
Full Kit: A67RK115	Head Kit: A67RK115A	Gasket Kit: A67RK115B	
			
Valve Kit: A67RK115C			

A67RK116

			
Full Kit: A67RK112	Head Kit: A67RK116A	Gasket Kit: A67RK116B	
			
Valve Kit: A67RK116C	Cooling Plate: A67RK116CP		

REPAIR KITS

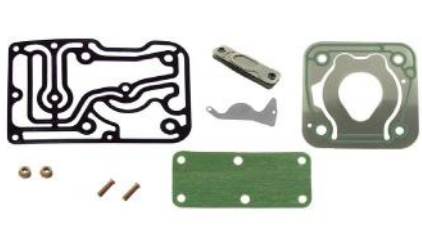
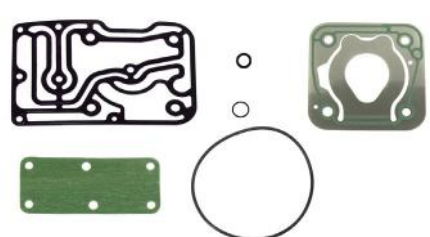

A67RK117

		
Full Kit: A67RK117	Head Kit: A67RK117A	Gasket Kit: A67RK117B
		
Valve Kit: A67RK117C		

A67RK118





		
Full Kit: A67RK118	Head Kit: A67RK118A	Gasket Kit: A67RK118B
		
	Valve Plate: A67RK118V	Valve Plate: A67RK118CP

A67RK119





		
Full Kit: A67RK119		
		
	Cooling Plate: A67RK119CP	Valve Plate: A67RK119V

REPAIR KITS





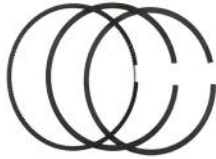

A67RK123

 <p>Full Kit: A67RK123</p>	 <p>Head Kit: A67RK123A</p>	 <p>Gasket Kit: A67RK123B</p>
 <p>Valve Kit: A67RK123C</p>		

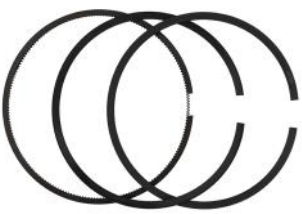
A67RK124 & A67RK126





 <p>Full Kit: A67RK124</p>	 <p>Head Kit: A67RK124A</p>	 <p>Gasket Kit: A67RK124B</p>
 <p>Valve Kit: A67RK124C</p>	 <p>Cooling Plate: A67RK124CP</p>	 <p>Full Kit: A67RK126</p>

A67RK127 & A67RK128

 <p>Full Kit: A67RK127</p>	 <p>Full Kit: A67RK128</p>	 <p>Head Kit: A67RK128</p>
 <p>Gasket Kit: A67RK128B</p>	 <p>Valve Kit: A67RK128C</p>	 <p>Valve Kit: A67RK128V</p>
		 <p>Cooling Plate: A67RK128CP</p>

REPAIR KITS

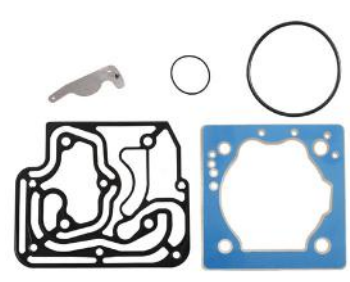

A67RK129

		
Full Kit: A67RK129	Head Kit: A67RK129A	Gasket Kit: A67RK129B
		
Valve Kit: A67RK129C		

A67RK130

		
Full Kit: A67RK130		

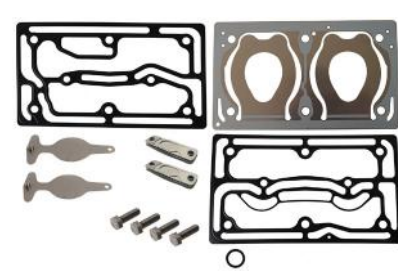
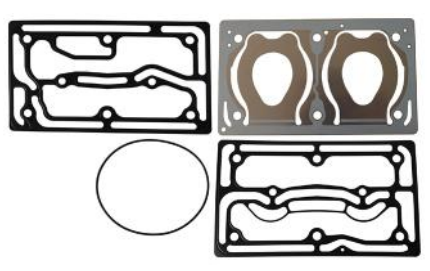
A67RK131

		
Full Kit: A67RK131	Head Kit: A67RK131A	Gasket Kit: A67RK131B
		
Valve Kit: A67RK131C	Cooling Plate: A67RK131V	

REPAIR KITS

A67RK132

			
<p>Full Kit: A67RK132</p>			

220034V



220056V





MAJORSELL

THE AIRBRAKE SPECIALIST

1980 40 YEARS 2020



More Information

For more information about the Majorsell product range visit our website or contact us.

++44 (0) 121 544 0951

sales@majorsell.co.uk

www.majorsell.co.uk

Suitable for the following applications:
Wabco, Man, Mercedes